

www.oscg.net

OSCG | 2022 | 10



OSCG

CABLE GLAND / JUNCTION BOX
hazardous & industrial area

Since Nov. 1983



Catalog Download

New Products : OS-EXBF-MC(19p), OS-E1UF-MC(24p), OSER-CS(35p)

Revisions from The Previous Catalogue (v2110 ▶ v2210)

No.	Old Page	New Page	Summary of Changes	Applicable Model
1	14~16	14~16	KCs Certificate No. added	OS-EXBF Series
2	17	17	Product changed to new model	OS-EXBF-F
3	18	18	Cable Diameter changed due to Flexible diameter	OS-EXBF-EP
4	N/A	19	New model for Metal Clad cable	OS-EXBF-MC
5	19~20	20~21	Cable Diameter changed due to Flexible diameter	OS-E1UF & /LS
6	21	22	Cable Diameter changed	OS-E1UF-EP
7	22	23	Product length changed	OS-E1UF-MH
8	N/A	24	New model for Metal Clad cable	OS-E1UF-MC
9	29	31	Cable Diameter changed due to Flexible diameter	OS-A2F-UEP
10	N/A	35	New model for easy installation for lighting	OSER-CS
11	33~34	36~37	Product length changed	OS-E1U & /LS
12	40 ~ 41	43 ~ 44	Cable Diameter changed due to Flexible diameter	OSEP / -W
13	43	46	Entry hole size change	OSWD-L
14	46	49	Cable Diameter changed	OSPGM & OSPGM-Z
15	47 ~ 50	50 ~ 53	Revised ATEX, IECEx Certificate No., QPS Certificate added	OSAJ & RA & SP & AE
16	50	53	Table Info changed	OSAE
17	46	49	Revised ATEX/IECEx Certificate No. and length added	OSBD
18	53	56	75<->75x typo error fixed	OSSH
19	55	58	PG Type P dimension typo fixed	OSLN
20	61	64	DNV Logo Removed(error), IP changed	OS-TOP
21	62	65	Internal Dimension "D" dimension fixed	OS-TOP
22	64	67	IP changed	OS-ITOP
23	65	68	121209B added, 5574 Size Mounting "A" dimension fixed (500->600) Internal Dimension "D" fixed	OS-ITOP
24	67	70	DNV Logo Removed(error), Earth Stud size fixed (M8 -> M6)	OSGP





CABLE GLAND / JUNCTION BOX

OSCG Since November 1983.

OSCG was established in 1983, and we have been specialized in Ex cable gland and junction box. We provide our cable gland and junction box with competitiveness, clients' satisfaction and requirements to many projects in the world. We have ISO 9001, 14001 and OHSAS 18001 and we are certified by Presafe IECEx, ATEX, TR CU and KCs explosion proof certificates. We are committed to enhancing customers easy and comfortable use on our products and keep making contribution for technology improvement and innovation.

Main Products

- ✓ **Explosion proof type Ex db & Ex eb & Ex tb CABLE GLAND**
: Certified by Presafe IECEx, ATEX, CU TR, KCs, DNV, RMRS, CCC, PESO
- ✓ **Explosion proof type Ex db & Ex eb & Ex tb REDUCER / ADAPTOR / STOPPING PLUG / ELBOW**
: Certified by Presafe IECEx, ATEX, CU TR, KCs, DNV, RMRS, CCC, PESO
- ✓ **Water proof & Weather proof CABLE GLAND**
: Certified by Presafe
- ✓ **JIS, DIN type CABLE GLAND and Flexible Connectors**
: Special cable connector for Vessels, Power Plants, On & Offshore
- ✓ **Explosion proof Ex e & Industrial type JUNCTION BOX**
: Certified by Presafe IECEx, ATEX



1983	Establishment	Oh-Sung Company established in Busan
1997		Moved to the current location at 1242 street, Nakdongdaero Sasang-Gu, Busan, Korea
2000	OSCG	Changed the Company name to "OSCG, Co.,Ltd"
	NEMKO	Certified by NEMKO for Ex Cable Gland
2001	SHELL	Approved by SHELL international exploration and production B.V for BONGA Project
2002	MOQ	Certified by MOQ for Exd CABLE GLAND of PLATFORMS
2003	ATEX	Certified by NEMKO ATEX for Exd type & Exe CABLE GLAND and component
	SHELL	Approved by Shell for Exd & Exe CABLE GLAND for BTIP Project
	TOTAL	Approved by TOTAL E&P for Exd & Exe CABLE GLAND for DALIA Project
2004	AGIP	Approved by AGIP GAS BV for Exd & Exe CABLE GLAND for SABRATHA Project
	GOST-R/FSETAN	Certified by GOST R/FSETAN for Exd & Exe CABLE GLAND, REDUCER ADAPTOR, STOPPING PLUG
2005	EXXON	Approved by Exxon for Exd & Exe CABLE GLAND for SAKHALIN OPF Project
2006	TATAL E&F	Approved by T.E.F for Exd & Exe CABLE GLAND for AKPO FPSO Project
	TOTAL	Approved by TOTAL for Exd & Exe CABLE GLAND for MOHO FPU Project
	SMEDVIG	Approved by SMEDVIG for Exd & Exe CABLE GLAND for WEST E-DRILL RIG Project
2007	ODFJELL	Approved by ODFJELL for Exd & Exe CABLE GLANDS for D-RIG Project
	TRANS OCEAN	Approved by TRANS-OCEAN for Exd & Exe CABLE GLANDS for D-SHIP Project
	TOTAL	Approved by TOTAL for Exd & Exe CABLE GLANDS for YADANA PLATFORM Project
	SEA-DRILL	Approved by SEA-DRILL for Exd & Exe CABLE GLANDS for D-RIG Project
2008	ISO 14001, ROHS	Certified ISO 14001, Approved ROHS
2009	IECEX SCHEME	Certified IECEX Scheme by KOSHA for Exd & Exe CABLE GLAND, Reducer, Adaptor, Stopping Plug
	TOTAL E&F	Certified by TOTAL for Exd & Exe CABLE GLANDS of PAZFLO FPSO Project
2011	GRP J/B	Certified by ATEX INERIS / IECEX
	ISO	ISO 9001:2008 and ISO 14001:2004 Review
2012	ATWOOD	Approved by ATWOOD for Exd & Exe CABLE GLANDS for D-SHIP Project
	TRANS OCEAN	Approved by TRANS OCEAN for Exd & Exe CABLE GLANDS for D-SHIP Project
2013	SHELL	Approved by SHELL for Exd & Exe CABLE GLANDS for SHELL FLNG Project
	SMBA	A Promising Export Firm by the Small & Medium Business Administration, Republic of Korea
	PETRONAS	Approved by PETRONAS for Exd & Exe CABLE GLANDS of PETRONAS FLNG Project
2014	ATEX/IECEX	ATEX/IECEX Review
2015	KCs	KCs certification approval
	DNV	DNV type approval
	RMRS	RMRS type approval
2016	CLASS NK	CLASS NK type approval
2017	ATEX/IECEX	Renewal Certificates
2018	ATEX/IECEX/TR CU	GRP/Stainless steel Junction Box
2019	CERTIFICATE	Compound Cable Gland
2020	CERTIFICATE	PESO, CCC Approved, renewal of DNV





OSCG Company was established in 1983

As a Cable Gland maker, we have been providing the best quality products for onshore and offshore projects. We always try our best to meet the requirement.



CERTIFICATES





MAJOR CLIENTS



Contents

Catalogue Corrections Notice	2
Introduce	4
Certificate	6
Major Customers	7
Contents	8
Fitting Instruction for Installation	9
Cable Gland Selection Chart	12
Technical	77
Installation manual for OS-EXBF	84
The type of thread on cable gland	86
Agencies	88

Compound Cable Gland

Compound for any type of armoured cable gland	OS-EXBF	14
Compound for any type of lead sheathed armoured cable gland	OS-EXBF/LS	15
Compound for non-armoured cable gland	OS-EXBF-A	16
Compound for packing type cable gland	OS-EXBF-F	17
Compound non-armoured cable with flexible conduit type	OS-EXBF-EP	18
Compound for Metal Clad Cable	OS-EXBF-MC	19

Ex Cable Gland

Any type of armoured cable gland	OS-E1UF	20
Any type of lead sheathed armoured cable gland	OS-E1UF/LS	21
Non-armoured cable with flexible conduit type	OS-E1UF-EP	22
Non-armoured cable with Male Female type	OS-E1UF-MH	23
Metal Clad type cable gland	OS-E1UF-MC	24
Non-armoured cable gland	OS-A2F-U	25
Non-armoured male and female cable gland	OS-A2F-UF	26
Non-armoured double compression cable gland	OS-A2F-UD	27
Heating type cable gland	OS-A2F-UH	28
Heat Tracing / Flat Form cable gland with Metal Hose	OS-A2F-UHMH	29
Non-armoured cable gland for metal hose	OS-A2F-UMH	30
Non-armoured cable gland for flexible	OS-A2F-UFP	31
Packing type cable gland	OSXP-F	32
Single compression with any type of armoured cable gland(touch)	OSER-Z	33
Non-armoured cable and Any Type of Armoured Cable(touch)	OSER-ZN	34
Contact insert type cable gland	OSER-CS	35

Non Ex (weatherproof) Cable Gland

Any type of armoured cable gland	OS-E1U	36
Any type of lead sheathed armoured cable gland	OS-E1U/LS	37
Armoured cable gland with single compression	OSCU	38
Non-armoured cable gland	OSNU	39
Non-armoured male and female cable gland	OSNU-F	40
Non-armoured double compression cable gland	OSNU-D	41
JIS standard cable gland	OSCG	42
Explosion proof flexible fittings	OSEP	43
One touch type OSEP	OSEP-W	44
Flexible packing type cable gland	OSXP & OSXP-W & OSXP-M	45
Welding type cable gland	OSWD & OSWD-L	46
Normal round type cable gland	OSPG-R	47
Round type plastic cable gland	OSPGR-P	48
DIN 89280 type cable gland	OSPGM & OSPGM-Z	49

Ex Certified Accessories

Adaptor	OSAJ	50
Reducer	OSRA	51
Stopping plug	OSSP	52
Elbow	OSAE	53
Insulated adaptor	OSAJ(I)	54
Breather drains	OSBD	54

Gland Accessories

Earth tag	OSET	55
EZsafe Compound Resin	OSEZ	55
Shroud	OSSH	56
Serrated washer / Teeth washer	OSTW	57
Lead sheath washer	OSLS	57
Lock nut	OSLN	58
Sealing washer	OSSR	59
Spanner	SPANNER	60

Junction Box Maximum Heat Dissipation

Junction Box Maximum Heat Dissipation Formula	63
---	----

Junction Box

Ex Stainless steel junction box	OS-TOP	64
Non-Ex Stainless steel junction box	OS-TOP	68
Ex GRP junction box	OSGP	70
Non-Ex GRP junction box	OSIGP	74

Instruction for Installation

Double Compression type Cable Gland

ATEX / IECEx Certificates ;

Ⓔ II 2G Ex db IIC Gb / Ex eb IIC Gb / II 2D Ex tb IIIC Db IP66/68

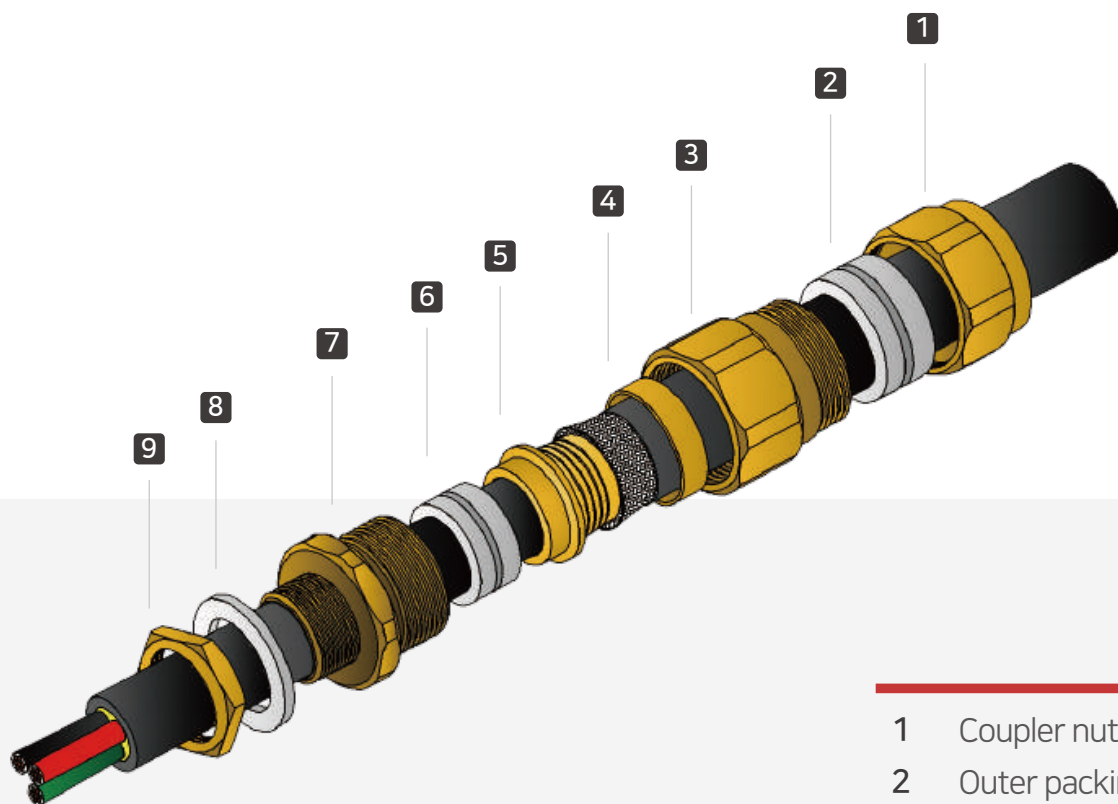

- 1 Coupler nut
- 2 Outer packing
- 3 Middle body
- 4 -Insert
- 5 +Insert
- 6 Inner packing
- 7 Hub body
- 8 IP Washer
- 9 Lock nut

Instruction for Installation

Double Compression type Cable Gland

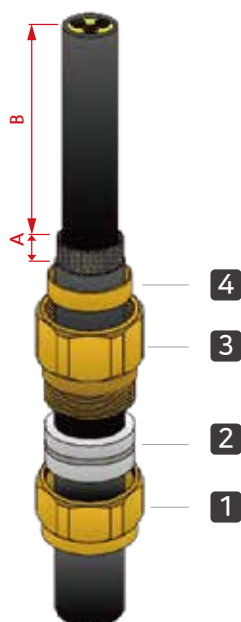

Prepere gland components as image I (if shroud is required, put it through the cable first)

Strip the outer sheath of cable and leave the amour length 'A'

A : 20mm for cable gland size 16 to 32

A : 25~32mm for cable gland size 40 to 115

B : Up to required length



Put the +insert[Ⓢ] through the cable, spread cable armour/ braid over the +insert[Ⓢ] until the end of the armour/braid is almost fitted against the shoulder of the +insert[Ⓢ].
Position the -insert[Ⓢ]

- Insert direction

Wire amoured
Position



Braid amoured
Position



To Entry ↑

BS 6121 Type of Gland
(The suffix for each type of protection)

Single wire armoured	W
Wire braided	X
Aluminium strip armoured	Y
Double steel tape armoured	Z

Instruction for Installation

Double Compression type Cable Gland

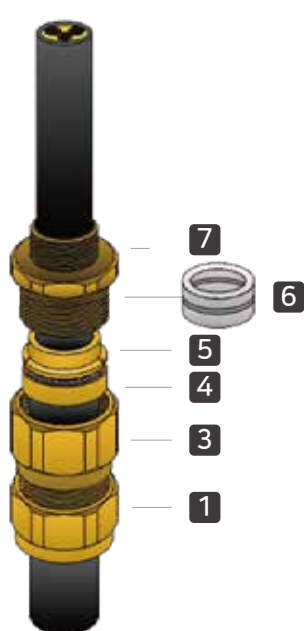

Put hub body⑦ and position on top of +insert⑤. Tighten coupler nut ① and middle body③

Note : if middle body③ and hub body⑦ do not meet due to the thickness of armour, recommend putting out inner packing⑥ and tighten without inner packing⑥.

Then, if +insert⑤ and -insert④ almost fit, redo it with inner packing ⑥ in original position

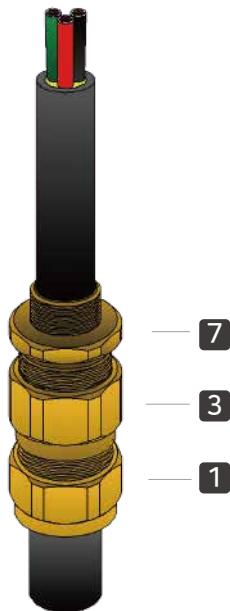

Position the gland to the equipment and hand tighten middle body③ and coupler nut ①. When hand-tighten is no more tightened, use the spanner to tighten middle body③ first until metal friction sounds. Then, tighten coupler nut ① by spanner one more turn

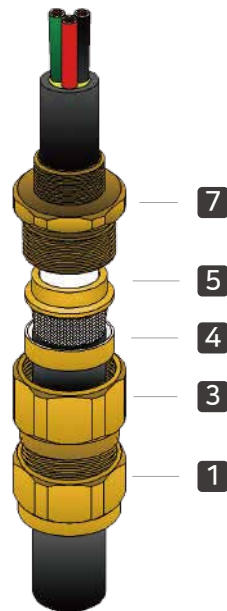

Untighten the middle body③ and visually inspect that the armour/ braid is successfully clamped between the +insert⑤ and the -insert④. If armour/braid not clamped, repeat assembly.

After tightening middle body③, complete coupler nut① refer to the table below.

Note

In the actual test for certificates, this instruction was carried out. If the installation is followed by this, the function of explosion proof, and ingress protection shall be achieved.

Thread of Middle body & Coupler nut [A]	Coupler nut tightening guide												
	Cable Out Dia per Gland Size (Unit : Ø)												
	16	20	25	32	40	50	63	63X	75	75X	90	100	115
0	9-15.5	14-20.5	17-26	24-33.5	30-41.5	38-50	45-60	55-66	58-72	66.1-79	72-90	84-101.5	100-116
0.5	9	-	17	24	30	38	45	-	-	-	-	-	-
1	11	-	19	27	32	40	47	-	58	-	72	-	-
1.5	12	14	21	30	34	42	49	55	60	66	74	82	100
2	13	15	22	32	36	44	51	57	62	68	76	85	103
2.5	14	16	23	33	38	45	53	59	64	70	78	88	106
3	15	17	24	33.5	39	46	55	61	66	72	80	90	108
3.5	15.5	18	25	-	40	47	57	63	68	74	82	92	110
4	-	19	26	-	41	48	58	64	70	76	84	94	112
4.5	-	20	-	-	41.5	49	59	65	71	78	86	96	114
5	-	20.5	-	-	-	50	60	66	72	79	88	98	115
	-	-	-	-	-	-	-	-	-	-	90	101.5	116



Cable Gland Selection Chart

Item	Area	Compression Type	Feature	Model	IP	Standard Thread	Page		
CABLE GLAND	Hazardous	Double Compression	Steel Wire Armour/Braided Wire Armour	OS-E1UF	66/68	Metric / Npt	20		
			Lead Sheath	OS-E1UF/LS	66/68		21		
			Non-armoured	OS-A2F-UD	66/68		27		
		Single Compression	Braided Wire Armour(Touch)	OSER-Z	66/68		33		
				OSER-ZN	66/68		34		
			Contact insert	OSER-CS	66/68		35		
			Non-armoured	OS-A2F-U	66/68		25		
			Conduit	OS-A2F-UF	66/68		26		
				OSXP-F	66/68		32		
			Flexible	OS-E1UF-EP	66/68		23		
				OS-A2F-UEP	66/68		31		
			Metal Hose	OS-A2F-UMH	66/68		30		
		Male & Female Threads	OS-E1UF-MH	66/68	23				
		Compound	Metal Clad	OS-E1UF-MC	66/68		24		
			Steel Wire Armour/Braided Wire Armour	OS-EXBF	66/68		14		
			Lead Sheath	OS-EXBF/LS	66/68		15		
			Non-armoured	OS-EXBF-A	66/68		16		
			Male & Female Threads	OS-EXBF-F	66/68		17		
			Conduit	OS-EXBF-EP	66/68		18		
			Metal Clad	OS-EXBF-MC	66/68		19		
		Heating Cable	Non-armoured	OS-A2F-UH	66/68		28		
	Metal Hose		OS-A2F-UHMH	66/68	29				
	Industrial	Double Compression	Steel Wire Armour/Braided Wire Armour	OS-E1U	66/68	Metric / Npt / PF / PG	36		
			Lead Sheath	OS-E1U/LS	66/68		37		
			Non-armoured	OSNU-D	66/68		41		
		Single Compression	Non-armoured	OSNU	66/68		39		
				OSCG	66		42		
				OSWD	66		46		
				OSPG-R	66/67		47		
				OSPG-R-P	66/68		48		
				OSPGM	66/67		49		
			Braided Wire Armour	OSPGM-Z	66/67		49		
		Steel Wire Armour/Braided Wire Armour	OSCU	66	38				
		Conduit	OSNU-F	66/68	40				
		NEC Standard	Double Compression	Steel Wire Armour/Braided Wire Armour	OS-E1UF		NEMA 4X	Metric / NPT	20
				Lead Sheath	OS-E1UF/LS		NEMA 4X		21
	Non-armoured			OS-A2F-UD	NEMA 4X	27			
	Single Compression		Non-armoured	OS-A2F-U	NEMA 4X	25			
			Conduit	OS-A2F-UF	NEMA 4X	26			
	OS-A2F-UEP			NEMA 4X	31				
	Compound		Steel Wire Armour/Braided Wire Armour	OS-EXBF	NEMA 4X	14			
			Lead Sheath	OS-EXBF/LS	NEMA 4X	15			
Non-armoured			OS-EXBF-A	NEMA 4X	16				
Male & Female Threads			OS-EXBF-F	NEMA 4X	17				
Heating Cable			OS-A2F-UH	NEMA 4X	28				
ACCESSORIES	Adaptor		OSAJ		66/68	Metric / Npt / PF / PG	50		
	Reducer		OSRA		66/68		51		
			OSSP(H)		66/68		52		
	Stopping Plug		OSSP(R)		66/68		52		
		OSSP(T)		66/68	52				
	Elbow	OSAE		66/68	53				
	Insulated Adaptor	OSAJ(I)		66/67	54				
	Breather Drain	OSBD		66	54				
	Earth Tag	OSET		N/A	55				
	Serrated Washer	OSTW		N/A	57				
	Lock Nut	OSLN		N/A	58				
	Sealing Washer	OSSR		N/A	59				
Shroud	OSSH		N/A	56					
JUNCTION BOX	Hazardous	Stainless Steel	OS-TOP	66/67	N/A	64			
		Glass Fibre Reinforced Polyester(GRP)	OSGP	66/67		70			
	Industrial	Stainless Steel	OS-ITOP	66/67		68			
		Glass Fibre Reinforced Polyester(GRP)	OSIGP	66/67		74			
	NEC Standard	Stainless Steel	OS-TOP	66/67		64			
		Glass Fibre Reinforced Polyester(GRP)	OSGP	66/67		70			

* In accordance with IEC 60079-1:2014, except for Metric and NPT, other external thread types previously permitted by earlier editions of IEC 60079-1. When a device includes external thread types from previous editions of IEC 60079-1, the device shall be marked with an indication of the thread type. The certificate shall also identify this thread type, along with the previous edition of IEC 60079-1 from which the thread type requirements were applied. NOTE 1 This allowance for the use of "other external thread types" is for the manufacture of replacement entry devices for equipment in existing installations only, that incorporate internal thread types that are no longer permitted by the current edition of IEC 60079-1.

* However, IEC 60079-1 refers to Ex db. If other threads are required for Ex eb, please contact us for further assistance.

OSCG Co.,Ltd.

CABLE GLAND / JUNCTION BOX
hazardous & industrial area

 OSCG

CABLE GLAND

Hazardous > Industrial > NEC Standard (in process)

OS-EXBF



Certificates	
Classifications	

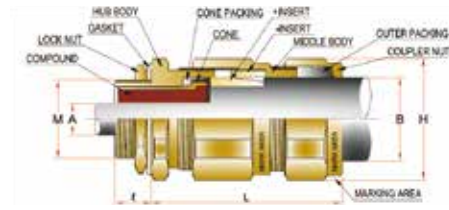

I Application

: Barrier Gland for Any Type of Armoured Cable

- For use with any type of armoured cable
- Ex 'db' barrier type
- Outdoor & Increased Safety.
- EMC cable gland. (360° contact) - EMC tested
- Reduce the effect of coldflow characteristics
- Double compression
- Liquid compound resin type
- OS-EXBF must be used with OSEZ (refer to OSEZ catalogue cut)

Design Specification	BS 6121, IEC 62444, EN 50262
Compliance Standard	IEC/EN 60079-0, 1, 7, 31
ATEX Certification	Presafe 18 ATEX 13521X
IECEX Certification	IECEX PRE 18.0074X
KCs Certification	18-KA2BO-0713~4X, 22-KA2BO-0443~4X
TR CU Certification	RU C- KR.AA87.B.00251/19
PESO Certification	P465223
CCC Certification	2020332313000660
INMETRO Certification	DNV 21.0152X
Code of Protection	II2G Ex db IIC Gb, Ex eb IIC Gb, II2D Ex tb IIIC Db
Operating Temperature	-60 ° C ~ 110 ° C
Regulation	Zone 1, 2 & 21, 22, Gas Group IIA, IIB and IIC, Dust Group IIIA, IIIB and IIIC
Ingress Protection (Metric) (NPT)	IP 66 / 68 (request in advance if IP68 required) NPT tapered hole : IP66 IP68(apply non-hardensng grease) Clearance hole : IP66/68(using IP Washer)
Applicable Cable Specification	Non-armoured cable, Braided armoured cable
Gland Material	Nickel plated brass(standard), Brass(only), Stainless steel(316L), Aluminum
Gasket (washer) Packing	Nylon(Standard), PTFE-Teflon(Option) Silicone
Accessories (optional)	Lock nut, Sealing washer, Earth tag, Shroud, Serrated washer

I Order Example

Part No.	Thread	Material	Accessories
OS-EXBF 20	M20	Nickel plated brass	Lock nut, Sealing washer, Earth tag, Serrated washer, Shroud

- Optional Thread Length : ≥15mm (Standard : M16 ~ M63 Length 15mm, M75 Length 20mm, M90 ~ M115 Length 25mm)
- Material for accessories is required
- Other than IECEX, ATEX and KCs marking, the marking requirement must be informed when ordered.

BS 6121 Type of Gland (The suffix for each type of protection)

Type	Suffix	Wire armoured Position	Braid armoured Position
Single wire armoured	W		
Wire braided	X		
Aluminium strip armoured	Y		
Double steel tape armoured	Z		

(* in mm)

Part No. (Gland Size)	Entry Thread Size(M)			Thread Length(ℓ) -Min			Cable Dia		Armour Size		Hexagon Dimensions	Weight (g)	Length (L)
	Metric	NPT	Option	Metric	NPT	Option	Inner 'A'	Outer 'B'	Wire	Braid			
OS-EXBF 16	M16	1/2"	M20	15	15	15	5 ~ 10	9 ~ 15.5	0.9 ~ 1.25	0.05 ~ 0.8	H25 x P27	137	56
OS-EXBF 20	M20	1/2"	3/4"	15	15	16	7.5 ~ 13.5	13.2 ~ 20.5	0.9 ~ 1.25	0.05 ~ 0.8	H31 x P34	212	63
OS-EXBF 25	M25	3/4"	1"	15	16	18	13 ~ 18.1	17 ~ 26	1.25 ~ 1.6	0.05 ~ 0.8	H37 x P40	325	68
OS-EXBF 32	M32	1"	1-1/4"	15	18	19	16.5 ~ 24.5	24 ~ 33.5	1.6 ~ 2.0	0.05 ~ 1.2	H47 x P50	570	75
OS-EXBF 40	M40	1-1/4"	1-1/2"	15	19	21	23 ~ 31.5	30 ~ 41.5	1.6 ~ 2.0	0.05 ~ 1.2	H56 x P60	876	83
OS-EXBF 50	M50	1-1/2"	2"	15	21	24	29 ~ 40.1	38 ~ 50	1.8 ~ 2.5	0.05 ~ 1.2	H70 x P75	1445	89
OS-EXBF 63	M63	2"		15	24		39 ~ 52.1	45 ~ 60	1.8 ~ 2.5	0.05 ~ 1.2	H77 x P82	1740	98
OS-EXBF 63X	M63		2-1/2"	15		27	46 ~ 54.1	55 ~ 66	1.8 ~ 2.5	0.05 ~ 1.2	H82 x P88	1907	98
OS-EXBF 75	M75	2-1/2"		20	27		52 ~ 60.9	58 ~ 72	1.8 ~ 2.5	0.05 ~ 1.2	H92 x P100	3270	109
OS-EXBF 75X	M75		3"	20		30	59 ~ 65.9	66.1 ~ 79	1.8 ~ 2.5	0.05 ~ 1.2	H98 x P106	2912	109
OS-EXBF 90	M90	3"	3-1/2"	25	30	32	66 ~ 77.8	72 ~ 90	1.8 ~ 3.0	0.05 ~ 1.6	H110 x P120	4600	111
OS-EXBF 100	M100	3-1/2"	4"	25	32	32	76 ~ 88.8	84 ~ 101.5	1.8 ~ 3.0	0.05 ~ 1.6	H125 x P135	5500	123
OS-EXBF 115	M115	4"		25	32		88 ~ 99.8	100 ~ 116	1.8 ~ 3.0	0.05 ~ 1.6	H135 x P143	5500	123

OS-EXBF/LS



Certificates	
Classifications	

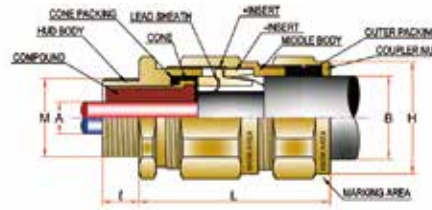

I Application

: Barrier Gland for Any Type of Lead Sheathed Armoured Cable

- For use with any type of Lead Sheathed Armoured Cable
- Ex 'db' barrier type
- Outdoor & Increased Safety.
- EMC cable gland. (360 ° contact) - EMC tested
- Reduce the effect of coldflow characteristics
- Double compression
- Liquid compound resin type
- OS-EXBF/LS must be used with OSEZ (refer to OSEZ catalogue cut)

Design Specification	BS 6121, IEC 62444, EN 50262
Compliance Standard	IEC/EN 60079-0, 1, 7, 31
ATEX Certification	Presafe 18 ATEX 13521X
IECEX Certification	IECEX PRE 18.0074X
KCs Certification	18-KA2BO-0713~4X, 22-KA2BO-0443~4X
TR CU Certification	RU C - KR.AA87.B.00251/19
PESO Certification	P465223
CCC Certification	2020332313000665
INMETRO Certification	DNV 21.0152X
Code of Protection	II2G Ex db IIC Gb, Ex eb IIC Gb, II2D Ex tb IIIC Db
Operating Temperature	-60 ° C ~ 110 ° C
Regulation	Zone 1, 2 & 21, 22, Gas Group IIA, IIB and IIC, Dust Group IIIA, IIIB and IIIC
Ingress Protection (Metric) (NPT)	IP 66 / 68 (request in advance if IP68 required) NPT tapered hole : IP66 IP68 (apply non-hardening grease) Clearance hole : IP66/68 (using IP Washer)
Applicable Cable Specification	Non-armoured cable, Braided armoured cable
Gland Material	Nickel plated brass (standard), Brass (only), Stainless steel (316L), Aluminum
Gasket (washer)	Nylon (Standard), PTFE-Teflon (Option)
Packing	Silicone
Accessories (optional)	Lock nut, Sealing washer, Earth tag, Shroud, Serrated washer

I Order Example

Part No.	Thread	Material	Accessories
OS-EXBF/LS 20	M20	Nickel plated brass	Lock nut, Sealing washer, Earth tag, Serrated washer, Shroud

- Optional Thread Length : ≥15mm (Standard : M16 ~ M63 Length 15mm, M75 Length 20mm, M90 ~ M115 Length 25mm)
- Material for accessories is required
- Other than IECEX, ATEX and KCs marking, the marking requirement must be informed when ordered.

BS 6121 Type of Gland (The suffix for each type of protection)

Single wire armoured	W	
Wire braided	X	
Aluminium strip armoured	Y	
Double steel tape armoured	Z	

(* in mm)

Part No. (Gland Size)	Entry Thread Size(M)			Thread Length(ℓ) -Min			Cable Dia		Armour Size		Hexagon Dimensions	Weight (g)	Length (L)
	Metric	NPT	Option	Metric	NPT	Option	Inner 'A'	Outer 'B'	Wire	Braid			
OS-EXBF/LS 16	M16	1/2"	M20	15	15	15	5 ~ 10	9 ~ 15.5	0.9 ~ 1.25	0.05 ~ 0.8	H25 x P27	137	56
OS-EXBF/LS 20	M20	1/2"	3/4"	15	15	16	7.5 ~ 13.5	13.2 ~ 20.5	0.9 ~ 1.25	0.05 ~ 0.8	H31 x P34	212	63
OS-EXBF/LS 25	M25	3/4"	1"	15	16	18	13 ~ 18.1	17 ~ 26	1.25 ~ 1.6	0.05 ~ 0.8	H37 x P40	325	68
OS-EXBF/LS 32	M32	1"	1-1/4"	15	18	19	16.5 ~ 24.5	24 ~ 33.5	1.6 ~ 2.0	0.05 ~ 1.2	H47 x P50	570	75
OS-EXBF/LS 40	M40	1-1/4"	1-1/2"	15	19	21	23 ~ 31.5	30 ~ 41.5	1.6 ~ 2.0	0.05 ~ 1.2	H56 x P60	876	83
OS-EXBF/LS 50	M50	1-1/2"	2"	15	21	24	29 ~ 40.1	38 ~ 50	1.8 ~ 2.5	0.05 ~ 1.2	H70 x P75	1445	89
OS-EXBF/LS 63	M63	2"		15	24		39 ~ 52.1	45 ~ 60	1.8 ~ 2.5	0.05 ~ 1.2	H77 x P82	1740	98
OS-EXBF/LS 63X	M63		2-1/2"	15		27	46 ~ 54.1	55 ~ 66	1.8 ~ 2.5	0.05 ~ 1.2	H82 x P88	1907	98
OS-EXBF/LS 75	M75	2-1/2"		20	27		52 ~ 60.9	58 ~ 72	1.8 ~ 2.5	0.05 ~ 1.2	H92 x P100	3270	109
OS-EXBF/LS 75X	M75		3"	20		30	59 ~ 65.9	66.1 ~ 79	1.8 ~ 2.5	0.05 ~ 1.2	H98 x P106	2912	109
OS-EXBF/LS 90	M90	3"	3-1/2"	25	30	32	66 ~ 77.8	72 ~ 90	1.8 ~ 3.0	0.05 ~ 1.6	H110 x P120	4600	111
OS-EXBF/LS 100	M100	3-1/2"	4"	25	32	32	76 ~ 88.8	84 ~ 101.5	1.8 ~ 3.0	0.05 ~ 1.6	H125 x P135	5500	123
OS-EXBF/LS 115	M115	4"		25	32		88 ~ 99.8	100 ~ 116	1.8 ~ 3.0	0.05 ~ 1.6	H135 x P143	5500	123

※ The entry holes need not greater than 0.7mm ※ Up to M75, 1.5 pitch is standard and from M90, 2.0 pitch is standard

OS-EXBF-A

Certificates	
Classifications	

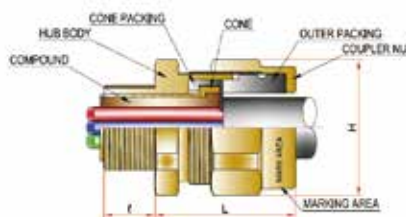

I Application : Barrier Gland for Non-Armoured Cable

- For use with non-armoured & braided armoured cable
- Ex 'db' barrier type
- Outdoor & Increased safety
- Reduce the effect of coldflow characteristics
- Liquid compound resin typ
- OS-EXBF-A must be used with OSEZ (refer to OSEZ catalogue cut)

Design Specification	BS 6121, IEC 62444, EN 50262
Compliance Standard	IEC/EN 60079-0, 1, 7, 31
ATEX Certification	Presafe 18 ATEX 13521X
IECEX Certification	IECEX PRE 18.0074X
KCs Certification	18-KA2BO-0713~4X, 22-KA2BO-0443~4X
TR CU Certification	RU C- KR.AA87.B.00251/19
PESO Certification	P465223
CCC Certification	2020332313000665
INMETRO Certification	DNV 21.0152X
Code of Protection	II2G Ex db IIC Gb, Ex eb IIC Gb, II2D Ex tb IIIC Db
Operating Temperature	-60 ° C ~ 110 ° C
Regulation	Zone 1, 2 & 21, 22, Gas Group IIA, IIB and IIC, Dust Group IIIA, IIIB and IIIC
Ingress Protection (Metric) (NPT)	IP 66 / 68 (request in advance if IP68 required) NPT tapered hole : IP66 IP68(apply non-hardening grease) Clearance hole : IP66/68(using IP Washer)
Applicable Cable Specification	Non-armoured cable, Braided armoured cable
Gland Material	Nickel plated brass(standard), Brass(only), Stainless steel(316L)
Gasket (washer)	Nylon(Standard), PTFE-Teflon(Option)
Packing	Silicone
Accessories (optional)	Lock nut, Sealing washer, Earth tag, Shroud, Serrated washer

I Order Example

Part No.	Thread	Material	Accessories
OS-EXBF-A 20	M20	Nickel plated brass	Lock nut, Sealing washer, Earth tag, Serrated washer, Shroud

- Optional Thread Length : ≥15mm (Standard : M16 ~ M63 Length 15mm, M75 Length 20mm, M90 ~ M115 Length 25mm)
- Material for accessories is required

- Other than IECEX, ATEX and KCs marking, the marking requirement must be informed when ordered.

(* in mm)

Part No. (Gland Size)	Entry Thread Size(M)			Thread Length(l)-Min			Cable Dia	Hexagon Dimensions	Weight (g)	Length (L)
	Metric	NPT	Option	Metric	NPT	Option				
OS-EXBF-A 16	M16	1/2"	M20	15	15	15	5 ~ 10	H25 x P27	72	34
OS-EXBF-A 20	M20	1/2"	3/4"	15	15	16	7.5 ~ 13.5	H31 x P34	79	38
OS-EXBF-A 25	M25	3/4"	1"	15	16	18	13 ~ 18.1	H37 x P40	108	42
OS-EXBF-A 32	M32	1"	1-1/4"	15	18	19	16.5 ~ 24.5	H47 x P50	168	45
OS-EXBF-A 40	M40	1-1/4"	1-1/2"	15	19	21	23 ~ 31.5	H56 x P60	272	50
OS-EXBF-A 50	M50	1-1/2"	2"	15	21	24	29 ~ 40.1	H70 x P75	371	53
OS-EXBF-A 63	M63	2"		15	24		39 ~ 50	H77 x P82	720	57
OS-EXBF-A 63X	M63	2"	2-1/2"	15	24	27	46 ~ 54.1	H82 x P88	600	58
OS-EXBF-A 75	M75	2-1/2"		20	27		52 ~ 60.9	H92 x P100	950	59
OS-EXBF-A 75X	M75		3"	20	27	30	59 ~ 65.9	H98 x P106	1070	61
OS-EXBF-A 90	M90	3"	3-1/2"	25	30	32	66 ~ 77.8	H110 x P120	1480	71
OS-EXBF-A 100	M100	3-1/2"	4"	25	32	32	76 ~ 88.8	H125 x P135	2250	73
OS-EXBF-A 115	M115	4"		25	32		88 ~ 99.8	H135 x P143	2400	78

※ The entry holes need not greater than 0.7mm ※ Up to M75, 1.5 pitch is standard and from M90, 2.0 pitch is standard

OS-EXBF-F



Certificates	
Classifications	

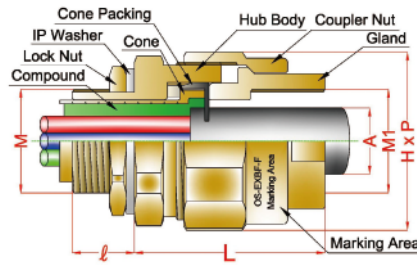

I Application

: Barrier Gland for Non-Armoured Cable with Male Female Type

- For use with non-armoured & braided armoured cable
- Male and Female threads type
- Ex 'db' barrier type
- Outdoor & Increased safety
- Reduce the effect of coldflow characteristics
- Liquid compound resin type
- Flexible conduit provided when requested only (refer to OSEP catalogue cut)
- OS-EXBF-F must be used with OSEZ (refer to OSEZ catalogue cut)

Design Specification	BS 6121, IEC 62444, EN 50262
Compliance Standard	IEC/EN 60079-0, 1, 7, 31
ATEX Certification	Presafe 18 ATEX 13521X
IECEX Certification	IECEX PRE 18.0074X
KCs Certification	18-KA2BO-0713~4X, 22-KA2BO-0443~4X
TR CU Certification	RU C-KR.AA87.B.00251/19
PESO Certification	P465223
CCC Certification	2020332313000665
INMETRO Certification	DNV 21.0152X
Code of Protection	II2G Ex db IIC Gb, Ex eb IIC Gb, II2D Ex tb IIIC Db
Operating Temperature	-60 °C ~ 110 °C
Regulation	Zone 1, 2 & 21, 22, Gas Group IIA, IIB, IIC, Dust Group IIIA, IIIB, IIIC
Ingress Protection (Metric)	IP 66 / 68 (request in advance if IP68 required)
(NPT)	NPT tapered hole : IP66 IP68(apply non-hardening grease)
	Clearance hole : IP66/68(using IP Washer)
Applicable Cable Specification	Non-armoured cable, Braided armoured cable
Gland Material	Nickel plated brass(standard), Brass(only), Stainless steel(316L)
Gasket (washer)	Nylon(Standard), PTFE-Teflon(Option)
Packing	Silicone
Accessories (optional)	Lock nut, Sealing washer, Earth tag, Shroud, Serrated washer

I Order Example

Part No.	Thread	Material	Accessories
OS-EXBF-F 20(F16)	M20	Nickel plated brass	Lock nut, Sealing washer, Earth tag, Serrated washer, Shroud

- Material for accessories is required
- Other than IECEX, ATEX and KCs marking, the marking requirement must be informed when ordered.

(* in mm)

Part No. (Gland Size)	Entry Thread Size(M1, M2)			Thread Length(ℓ)-Min			Cable Dia(A)	Hexagon Dimensions (HxP)	Length(L)
	Metric	NPT	Option	Metric	NPT	Option			
OS-EXBF-F 16(F16)	M16	1/2"	M20	15	15	15	5.0 ~ 11.5	H35 x P37	46
OS-EXBF-F 20(F16)	M20	1/2"	3/4"	15	15	16	7.5 ~ 15.2	H35 x P37	48
OS-EXBF-F 25(F22)	M25	3/4"	1"	15	16	18	13.0 ~ 19.6	H41 x P43	51
OS-EXBF-F 32(F28)	M32	1"	1-1/4"	15	18	19	16.5 ~ 26.2	H50 x P54	56
OS-EXBF-F 40(F36)	M40	1-1/4"	1-1/2"	15	19	21	23.0 ~ 32.3	H56 x P60	63
OS-EXBF-F 50(F42)	M50	1-1/2"	2"	15	21	24	29.0 ~ 41.5	H70 x P75	70
OS-EXBF-F 63(F54)	M63	2"	2-1/2"	15	24	27	39.0 ~ 50.0	H77 x P82	77
OS-EXBF-F 63X(F70)	M63	2-1/2"		15	27		46.0 ~ 55.0	H96 x P101	77
OS-EXBF-F 75(F70)	M75	2-1/2"	3"	20	27	30	52.0 ~ 61.0	H96 x P101	78
OS-EXBF-F 75X(F82)	M75	3"		20	30		59.0 ~ 67.0	H108 x P113	86
OS-EXBF-F 90(F82)	M90	3"	3-1/2"	25	30	32	66.0 ~ 80.0	H108 x P113	86
OS-EXBF-F 100(F104)	M100	3-1/2"	4"	25	32	32	76.0 ~ 90.5	H145 x P150	96
OS-EXBF-F 115(F104)	M115	4"		25	32		88.0 ~ 102.0	H145 x P150	96

※ The entry holes need not greater than 0.7mm

OS-EXBF-EP



Certificates	
Classifications	

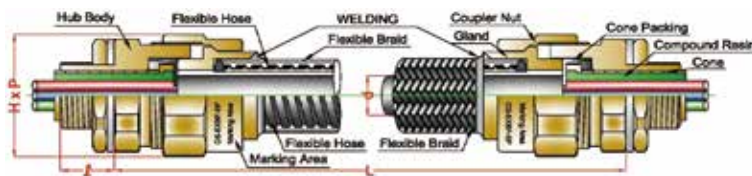

Application

: Barrier Gland for Non-Armoured Cable with flexible conduit type

- For use with non-armoured & braided armoured cable
- Cable used in narrow space or complicated area which requires flexibility
- Flameproof & Increased Safety
- Single compression
- Liquid compound resin type
- Flexible conduit alone cannot be certified
- Flexible conduit is a drain type standard
- OS-EXBF-EP must be used with OSEZ (refer to OSEZ catalogue cut)

Design Specification	BS 6121, IEC 62444, EN 50262
Compliance Standard	IEC/EN 60079-0, 1, 7, 31
ATEX Certification	Presafe 18 ATEX 13521X
IECEX Certification	IECEX PRE 18.0074X
KCs Certification	21-KA2BO-0000~0000X(Certification scheduled)
INMETRO Certification	DNV 21.0152X
Code of Protection	II2G Ex db IIC Gb, Ex eb IIC Gb, II2D Ex tb IIIC Db
Operating Temperature	-60 °C ~ 110 °C
Regulation	Zone 1, 2 & 21, 22, Gas Group IIA, IIB, IIC, Dust Group IIIA, IIIB, IIIC
Ingress Protection (Metric) (NPT)	IP 66 / 68 (request in advance if IP68 required) NPT tapered hole : IP66 IP68(apply non-hardensng grease) Clearance hole : IP66/68(using IP Washer)
Applicable Cable Specification	Non-armoured cable, Braided armoured cable
Thread Available	Male and Female type Male and Male type
Gland Material	Nickel plated brass(standard), Brass(only), Stainless steel(316L)
Flexible Material	Stainless steel(304, 316L)
Gasket (washer)	Nylon(Standard), PTFE-Teflon(Optional)
Packing	Silicone
Accessories (optional)	Lock nut, Sealing washer, Earth tag, Shroud, Serrated washer

Order Example

Part No.	Thread	Fixible(mm)	Type	Material	Accessories
OS-EXBF-EP 20	M20 NPT1/2"	500≤	A	Nickel plated brass	Lock nut, Sealing washer, Serrated washer

• Optional Thread Length : ≥15mm (Standard : M16 ~ M63 Length 15mm, M75 Length 20mm, M90 ~ M115 Length 25mm)
 • Material for accessories is required

(* in mm)

Part No. (Gland Size)	Entry Thread Size(M1, M2)			Thread Length(ℓ)-Min			Cable Dia(d)		Hexagon Dimensions (HxP)	Length(L)	
	Metric	NPT	Option	Metric	NPT	Option	Waterproof	Waterdrain		Gland	Flexible
OS-EXBF-EP 16(F16)	M16	1/2"	M20	15	15	15	5.0~11.5	5.0~11.5	H35 x P37	43	Standard 500mm 700mm 1000mm ≤
OS-EXBF-EP 20(F16)	M20	1/2"	3/4"	15	15	16	7.5~13.0	7.5~15.2	H35 x P37	43	
OS-EXBF-EP 25(F22)	M25	3/4"	1"	15	16	18	13.0~18.0	13.0~19.6	H41 x P43	48	
OS-EXBF-EP 32(F28)	M32	1"	1-1/4"	15	18	19	16.5~24.5	16.5~26.2	H50 x P54	51	
OS-EXBF-EP 40(F36)	M40	1-1/4"	1-1/2"	15	19	21	23.0~31.0	23.0~32.3	H56 x P60	60	
OS-EXBF-EP 50(F42)	M50	1-1/2"	2"	15	21	24	29.0~36.5	29.0~40.0	H70 x P75	66	
OS-EXBF-EP 50(F54)	M50	1-1/2"	2"	15	21	24	33.0~41.5	33.0~41.5	H77 x P82	70	
OS-EXBF-EP 63(F54)	M63	2"	2-1/2"	15	24	27	39~46	39~50	H77 x P82	70	
OS-EXBF-EP 63X(F70)	M63	2-1/2"		15	27		46~55	46~55	H96 x P101	70	
OS-EXBF-EP 75(F70)	M75	2-1/2"	3"	20	27	30	52~61	52~61	H96 x P101	71	
OS-EXBF-EP 75X(F82)	M75	3"		20	30		59~67	59~67	H108 x P113	78	
OS-EXBF-EP 90(F82)	M90	3"	3-1/2"	25	30	32	66~80	66~80	H108 x P113	78	
OS-EXBF-EP 100(F104)	M100	3-1/2"	4"	25	32	32	76~90.5	76~90.5	H145 x P150	94	
OS-EXBF-EP 115(F104)	M115	4"		25	32		88~100	88~100	H145 x P150	94	

※ The entry holes need not greater than 0.7mm ※ Up to M75, 1.5 pitch is standard and from M90, 2.0 pitch is standard

OS-EXBF-MC



Certificates	
Classifications	

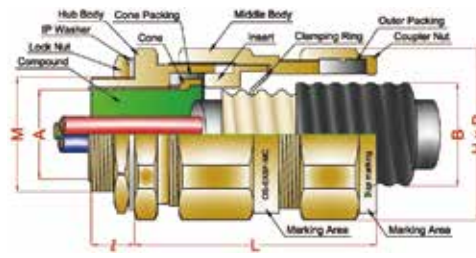

I Application : Barrier Gland for Metal Clad Cable

- For use with any type of armoured cable
- Ex 'db' barrier type
- Outdoor & Increased Safety.
- EMC cable gland. (360 ° contact) - EMC tested
- Reduce the effect of coldflow characteristics
- Double compression
- Liquid compound resin type
- OS-EXBF must be used with OSEZ (refer to OSEZ catalogue cut)

Design Specification	BS 6121, IEC 62444, EN 50262
Compliance Standard	IEC/EN 60079-0, 1, 7, 31
ATEX Certification	Presafe 18 ATEX 13521X
IECEX Certification	IECEX PRE 18.0074X
KCs Certification	18-KA2BO-0713~4X, 22-KA2BO-0443~4X
Code of Protection	II2G Ex db IIC Gb, Ex eb IIC Gb, II2D Ex tb IIIC Db
Operating Temperature	-60 ° C ~ 110 ° C
Regulation	Zone 1, 2 & 21, 22, Gas Group IIA, IIB and IIC, Dust Group IIIA, IIIB and IIIC
Ingress Protection (Metric) (NPT)	IP 66 / 68 (request in advance if IP68 required) NPT tapered hole : IP66 IP68 (apply non-hardening grease) Clearance hole : IP66/68(using IP Washer)
Applicable Cable Specification	Non-armoured cable, Braided armoured cable
Gland Material	Nickel plated brass(standard), Brass(only), Stainless steel(316L), Aluminum
Gasket (washer)	Nylon(Standard), PTFE-Teflon(Option)
Packing	Silicone
Accessories (optional)	Lock nut, Sealing washer, Earth tag, Shroud, Serrated washer

I Order Example

Part No.	Thread	Material	Accessories
OS-EXBF-MC 20	M20	Nickel plated brass	Lock nut, Sealing washer, Earth tag, Serrated washer, Shroud

- Optional Thread Length : ≥15mm (Standard : M16 ~ M63 Length 15mm, M75 Length 20mm, M90 ~ M115 Length 25mm)
- Material for accessories is required
- Other than IECEX, ATEX and KCs marking, the marking requirement must be informed when ordered.

(* in mm)

Part No. (Gland Size)	Entry Thread Size(M)			Thread Length(ℓ) -Min			Cable Dia		Hexagon Dimensions	Weight (g)	Length (L)
	Metric	NPT	Option	Metric	NPT	Option	Inner 'A' (Max)	Outer 'B'			
OS-EXBF-MC 16	M16	1/2"	M20	15	15	15	8.7	9 ~ 15.5	H25 x P27	137	56
OS-EXBF-MC 20	M20	1/2"	3/4"	15	15	16	12.1	13.2 ~ 20.5	H31 x P34	212	63
OS-EXBF-MC 25	M25	3/4"	1"	15	16	18	16.1	17 ~ 26	H37 x P40	325	68
OS-EXBF-MC 32	M32	1"	1-1/4"	15	18	19	20.8	24 ~ 33.5	H47 x P50	570	75
OS-EXBF-MC 40	M40	1-1/4"	1-1/2"	15	19	21	27.0	30 ~ 41.5	H56 x P60	876	83
OS-EXBF-MC 50	M50	1-1/2"	2"	15	21	24	35.0	38 ~ 50	H70 x P75	1445	89
OS-EXBF-MC 63	M63	2"		15	24		37.0	45 ~ 60	H77 x P82	1740	98
OS-EXBF-MC 63X	M63		2-1/2"	15		27	48.0	55 ~ 66	H82 x P88	1907	98
OS-EXBF-MC 75	M75	2-1/2"		20	27		48.0	58 ~ 72	H92 x P100	3270	109
OS-EXBF-MC 75X	M75		3"	20		30	53.0	66.1 ~ 79	H98 x P106	2912	109
OS-EXBF-MC 90	M90	3"	3-1/2"	25	30	32	66.0	72 ~ 90	H110 x P120	4600	111
OS-EXBF-MC 100	M100	3-1/2"	4"	25	32	32	80.0	84 ~ 101.5	H125 x P135	5500	123
OS-EXBF-MC 115	M115	4"		25	32		80.0	100 ~ 116	H135 x P143	5500	123

※ The entry holes need not greater than 0.7mm ※ Up to M75, 1.5 pitch is standard and from M90, 2.0 pitch is standard

OS-E1UF

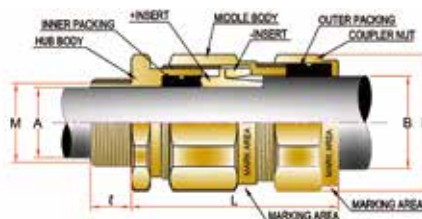

Certificates	
Classifications	

Application : Any Type of Armoured Cable

- For use with any type of armoured cable
- Outdoor & Indoor use
- Flameproof & Increased Safety
- EMC cable gland. (360 ° contact) - EMC tested
- Reduce the effect of coldflow characteristics
- Double compression

Design Specification	BS 6121, IEC 62444, EN 50262
Compliance Standard	IEC/EN 60079-0, 1, 7, 31
ATEX Certification	Presafe 17 ATEX 11456X
IECEX Certification	IECEX PRE 17.0063X
KCs Certification	18-KA2BO-0212~9X, 18-KA2BO-0236~9X
TR CU Certification	RU C - KRAA87.B.01105
PESO Certification	P465223
CCC Certification	2020332313000759
INMETRO Certification	DNV 21.0149X
Code of Protection	II2G Ex db IIC Gb, Ex eb IIC Gb, II2D Ex tb IIIC Db
Operating Temperature	-60 ° C ~ 110 ° C
Regulation	Zone 1,2 & 21,22, Gas Group IIA, IIB, IIC, Dust Group IIIA, IIIB, IIIC
Ingress Protection (Metric)	IP 66 / 68 (request in advance if IP68 required)
(NPT)	NPT tapered hole : IP66 IP68(apply non-hardensng grease) Clearance hole : IP66/68(using IP Washer)
Applicable Cable Specification	All types of armoured cable
Gland Material	Nickel plated brass(standard), Brass(only), Stainless steel(316L), Aluminum
Gasket (washer)	Nylon(Standard), PTFE-Teflon(Option)
Packing	Silicone
Accessories (optional)	Lock nut, Sealing washer, Earth tag, Shroud, Serrated washer

Order Example

Part No.	Thread	Material	Accessories
OS-E1UF 20	M20	Nickel plated brass	Lock nut, Sealing washer, Earth tag, Serrated washer, Shroud

- Optional Thread Length : ≥15mm (Standard : M16 ~ M63 Length 15mm, M75 Length 20mm, M90 ~ M115 Length 25mm)
- Material for accessories is required
- Other than IECEx, ATEX and KCs marking, the marking requirement must be informed when ordered.

BS 6121 Type of Gland (The suffix for each type of protection)

Single wire armoured	W	Wire armoured Position	Braid armoured Position
Wire braided	X		
Aluminium strip armoured	Y		
Double steel tape armoured	Z		

(* in mm)

Part No. (Gland Size)	Entry Thread Size(M)			Thread Length(ℓ) - Min			Cable Dia		Armour Size		Hexagon Dimensions	Weight (g)	Length (L)
	Metric	NPT	Option	Metric	NPT	Option	Inner 'A'	Outer 'B'	Wire	Braid			
OS-E1UF 16	M16	1/2"	M20	15	15	15	5 ~ 11.5	9 ~ 15.5	0.9 ~ 1.25	0.05 ~ 0.8	H25 x P27	137	58
OS-E1UF 20	M20	1/2"	3/4"	15	15	16	7.5 ~ 15.2	13.2~20.5	0.9 ~ 1.25	0.05 ~ 0.8	H31 x P34	212	66
OS-E1UF 25	M25	3/4"	1"	15	16	18	13 ~ 19.6	17 ~ 26	1.25 ~ 1.6	0.05 ~ 0.8	H37 x P40	325	68
OS-E1UF 32	M32	1"	1-1/4"	15	18	19	16.5 ~ 26.2	24 ~ 33.5	1.6 ~ 2.0	0.05 ~ 1.2	H47 x P50	570	75
OS-E1UF 40	M40	1-1/4"	1-1/2"	15	19	21	23 ~ 32.3	30 ~ 41.5	1.6 ~ 2.0	0.05 ~ 1.2	H56 x P60	876	86
OS-E1UF 50	M50	1-1/2"	2"	15	21	24	29 ~ 41.5	38 ~ 50	1.8 ~ 2.5	0.05 ~ 1.2	H70 x P75	1445	93
OS-E1UF 63	M63	2"		15	24		39 ~ 50	45 ~ 60	1.8 ~ 2.5	0.05 ~ 1.2	H77 x P82	1740	103
OS-E1UF 63X	M63		2-1/2"	15		27	46 ~ 55	55 ~ 66	1.8 ~ 2.5	0.05 ~ 1.2	H82 x P88	1907	104
OS-E1UF 75	M75	2-1/2"		20	27		52 ~ 61	58 ~ 72	1.8 ~ 2.5	0.05 ~ 1.2	H92 x P100	3270	110
OS-E1UF 75X	M75		3"	20		30	59 ~ 67	66.1 ~ 79	1.8 ~ 2.5	0.05 ~ 1.2	H98 x P106	2912	113
OS-E1UF 90	M90	3"	3-1/2"	25	30	32	66 ~ 80	72 ~ 90	1.8 ~ 3.0	0.05 ~ 1.6	H110 x P120	4600	128
OS-E1UF 100	M100	3-1/2"	4"	25	32	32	76 ~ 90.5	84 ~ 101.5	1.8 ~ 3.0	0.05 ~ 1.6	H125 x P135	5500	134
OS-E1UF 115	M115	4"		25	32		88 ~ 102	100 ~ 116	1.8 ~ 3.0	0.05 ~ 1.6	H135 x P143	5500	141

OS-E1UF/LS



Certificates	
Classifications	

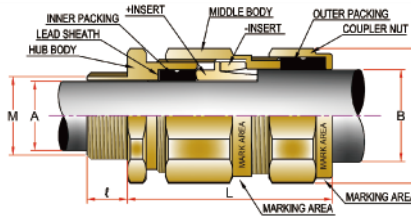

I Application

: Any Type of Lead Sheathed Armoured Cable

- For use with any type of lead sheathed armoured cable
- Outdoor & Indoor use
- Flameproof & Increased Safety
- EMC cable gland. (360 ° contact) - EMC tested
- Reduce the effect of coldflow characteristics
- Double compression

Design Specification	BS 6121, IEC 62444, EN 50262
Compliance Standard	IEC/EN 60079-0, 1, 7, 31
ATEX Certification	Presafe 17 ATEX 11456X
IECEX Certification	IECEX PRE 17.0063X
KCs Certification	18-KA2BO-0212~9X, 18-KA2BO-0236~9X
TR CU Certification	RU C- KR.AA87.B.01105
PESO Certification	P465223
CCC Certification	2020332313000759
INMETRO Certification	DNV 21.0149X
Code of Protection	II2G Ex db IIC Gb, Ex eb IIC Gb, II2D Ex tb IIIC Db
Operating Temperature	-60 ° C ~ 110 ° C
Regulation	Zone 1, 2 & 21, 22, Gas Group IIA, IIB, IIC, Dust Group IIIA, IIIB, IIIC
Ingress Protection (Metric)	IP 66 / 68 (request in advance if IP68 required)
(NPT)	NPT tapered hole : IP66 IP68 (apply non-hardensng grease) Clearance hole : IP66/68(using IP Washer)
Applicable Cable Specification	All types of armoured cable
Gland Material	Nickel plated brass(standard), Brass(only), Stainless steel(316L), Aluminum
Gasket (washer)	Nylon(Standard), PTFE-Teflon(Option)
Packing	Silicone
Accessories (optional)	Lock nut, Sealing washer, Earth tag, Shroud, Serrated washer

I Order Example

Part No.	Thread	Material	Accessories
OS-E1UF/LS 20	M20	Nickel plated brass	Lock nut, Sealing washer, Earth tag, Serrated washer, Shroud

- Optional Thread Length : ≥15mm (Standard : M16 ~ M63 Length 15mm, M75 Length 20mm, M90 ~ M115 Length 25mm)
- Material for accessories is required
- Other than IECEx, ATEX and KCs marking, the marking requirement must be informed when ordered.

BS 6121 Type of Gland (The suffix for each type of protection)

Single wire armoured	W	Wire armoured Position	Braid armoured Position	To Entry ↑
Wire braided	X			
Aluminium strip armoured	Y			
Double steel tape armoured	Z			

(* in mm)

Part No. (Gland Size)	Entry Thread Size(M)			Thread Length(ℓ) - Min			Cable Dia		Armour Size		Hexagon Dimensions	Weight (g)	Length (L)
	Metric	NPT	Option	Metric	NPT	Option	Inner 'A'	Outer 'B'	Wire	Braid			
OS-E1UF/LS 16	M16	1/2"	M20	15	15	15	5 ~ 11.5	9 ~ 15.5	0.9 ~ 1.25	0.05 ~ 0.8	H25 x P27	137	58
OS-E1UF/LS 20	M20	1/2"	3/4"	15	15	16	7.5 ~ 15.2	13.2~20.5	0.9 ~ 1.25	0.05 ~ 0.8	H31 x P34	212	66
OS-E1UF/LS 25	M25	3/4"	1"	15	16	18	13 ~ 19.6	17 ~ 26	1.25 ~ 1.6	0.05 ~ 0.8	H37 x P40	325	68
OS-E1UF/LS 32	M32	1"	1-1/4"	15	18	19	16.5 ~ 26.2	24 ~ 33.5	1.6 ~ 2.0	0.05 ~ 1.2	H47 x P50	570	75
OS-E1UF/LS 40	M40	1-1/4"	1-1/2"	15	19	21	23 ~ 32.3	30 ~ 41.5	1.6 ~ 2.0	0.05 ~ 1.2	H56 x P60	876	86
OS-E1UF/LS 50	M50	1-1/2"	2"	15	21	24	29 ~ 41.5	38 ~ 50	1.8 ~ 2.5	0.05 ~ 1.2	H70 x P75	1445	93
OS-E1UF/LS 63	M63	2"		15	24		39 ~ 50	45 ~ 60	1.8 ~ 2.5	0.05 ~ 1.2	H77 x P82	1740	103
OS-E1UF/LS 63X	M63		2-1/2"	15		27	46 ~ 55	55 ~ 66	1.8 ~ 2.5	0.05 ~ 1.2	H82 x P88	1907	104
OS-E1UF/LS 75	M75	2-1/2"		20	27		52 ~ 61	58 ~ 72	1.8 ~ 2.5	0.05 ~ 1.2	H92 x P100	3270	110
OS-E1UF/LS 75X	M75		3"	20		30	59 ~ 67	66.1 ~ 79	1.8 ~ 2.5	0.05 ~ 1.2	H98 x P106	2912	113
OS-E1UF/LS 90	M90	3"	3-1/2"	25	30	32	66 ~ 80	72 ~ 90	1.8 ~ 3.0	0.05 ~ 1.6	H110 x P120	4600	128
OS-E1UF/LS 100	M100	3-1/2"	4"	25	32	32	76 ~ 90.5	84 ~ 101.5	1.8 ~ 3.0	0.05 ~ 1.6	H125 x P135	5500	134
OS-E1UF/LS 115	M115	4"		25	32		88 ~ 102	100 ~ 116	1.8 ~ 3.0	0.05 ~ 1.6	H135 x P143	5500	141

※ The entry need not greater than 0.7mm

※ Up to M75, 1.5 pitch is standard and from M90, 2.0 pitch is standard

OS-E1UF-EP



Certificates	CE, RoHS, REACH, etc.
Classifications	ATEX, IECEx, etc.

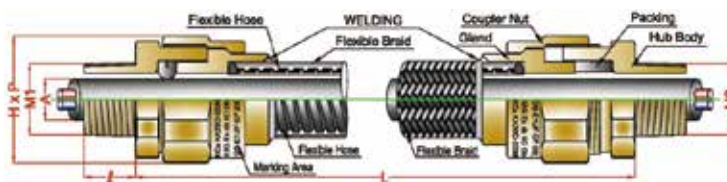

Application

: Non-Armoured Cable with Flexible Conduit Type

- For use with non-armoured & braided armoured
- Cable used in narrow space or complicated area which requires flexibility
- Flameproof & Increased Safety
- Single compression
- Flexible conduit alone cannot be certified
- Flexible conduit is a drain type standard

Design Specification	BS 6121, IEC 62444, EN 50262
Compliance Standard	IEC/EN 60079-0, 1, 7, 31
ATEX Certification	Presafe 17 ATEX 11456X
IECEx Certification	IECEx PRE 17.0063X
KCs Certification	18-KA2BO-0212~9X, 18-KA2BO-0236~9X
INMETRO Certification	DNV 21.0149X~9X
Code of Protection	IM2 Ex db Mb, Ex eb Mb II2G Ex db IIC Gb, Ex eb IIC Gb II2D Ex tb IIC Db
Operating Temperature	-60 °C ~ 110 °C
Regulation	Zone 1, 2 & 21, 22, Gas Group IIA, IIB, IIC, Dust Group IIIA, IIIB, IIIC
Ingress Protection (Metric) (NPT)	IP 66 / 68 (request in advance if IP68 required) NPT tapered hole : IP66 IP68(apply non-hardensng grease) Clearance hole : IP66/68(using IP Washer)
Applicable Cable Specification	Non-armoured cable, Braided armoured cable
Thread Available	Male and Female type Male and Male type
Gland Material	Nickel plated brass(standard), Brass(only), Stainless steel(316L)
Flexible Material	Stainless steel(304, 316L)
Gasket (washer)	Nylon(Standard), PTFE-Teflon(Option)
Packing	Silicone
Accessories (optional)	Lock nut, Sealing washer, Earth tag, Shroud, Serrated washer

Order Example

Part No.	Thread		Fixible(mm)	Type	Material	Accessories	• Optional Thread Length : ≥15mm • Material for accessories is required
	M1	M2					
OS-E1UF-EP 20(F-16)	M20	NPT1/2"	500≤	A	Nickel plated brass	Lock nut, Sealing washer, Serrated washer	

(* in mm)

Part No. (Gland Size)	Entry Thread Size(M1, M2)			Thread Length(L)-Min			Cable Dia(A)		Hexagon Dimensions (HxP)	Length(L)	
	Metric	NPT	Option	Metric	NPT	Option	Waterproof	Waterdrain		Gland	Flexible
OS-E1UF-EP 16(F16)	M16	1/2"	M20	15	15	15	5.0~11.5	5.0~11.5	H35 x P37	43	Standard 500mm 700mm 1000mm ≤
OS-E1UF-EP 20(F16)	M20	1/2"	3/4"	15	15	16	7.5~13.0	7.5~15.2	H35 x P37	43	
OS-E1UF-EP 25(F22)	M25	3/4"	1"	15	16	18	13.0~18.0	13.0~19.6	H41 x P43	48	
OS-E1UF-EP 32(F28)	M32	1"	1-1/4"	15	18	19	16.5~24.5	16.5~26.2	H50 x P54	51	
OS-E1UF-EP 40(F36)	M40	1-1/4"	1-1/2"	15	19	21	23.0~31.0	23.0~32.3	H56 x P60	60	
OS-E1UF-EP 50(F42)	M50	1-1/2"	2"	15	21	24	29.0~36.5	29.0~40.0	H70 x P75	66	
OS-E1UF-EP 50(F54)	M50	1-1/2"	2"	15	21	24	33.0~41.5	33.0~41.5	H77 x P82	70	
OS-E1UF-EP 63(F54)	M63	2"	2-1/2"	15	24	27	39~46	39~50	H77 x P82	70	
OS-E1UF-EP 63X(F70)	M63	2-1/2"		15	27		46~55	46~55	H96 x P101	70	
OS-E1UF-EP 75(F70)	M75	2-1/2"	3"	20	27	30	52~61	52~61	H96 x P101	71	
OS-E1UF-EP 75X(F82)	M75	3"		20	30		59~67	59~67	H108 x P113	78	
OS-E1UF-EP 90(F82)	M90	3"	3-1/2"	25	30	32	66~80	66~80	H108 x P113	78	
OS-E1UF-EP 100(F104)	M100	3-1/2"	4"	25	32	32	76~90.5	76~90.5	H145 x P150	94	
OS-E1UF-EP 115(F104)	M115	4"		25	32		88~100	88~100	H145 x P150	94	

※ The entry holes need not greater than 0.7mm ※ Up to M75, 1.5 pitch is standard and from M90, 2.0 pitch is standard

OS-E1UF-MH



Certificates	
Classifications	

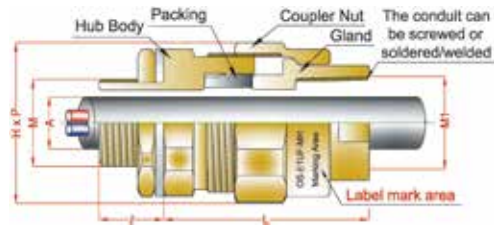

I Application : Non-Armoured Cable with Male Female Type

- For use with non-armoured & braided armoured cable
- Male and female threads type
- Flameproof & Increased Safety
- Single compression
- Flexible conduit provided when requested only (refer to OSEP catalogue cut)
- The conduit can be screwed or soldered/welded

Design Specification	BS 6121, IEC 62444, EN 50262
Compliance Standard	IEC/EN 60079-0, 1, 7, 31
ATEX Certification	Presafe 17 ATEX 11456X
IECEX Certification	IECEX PRE 17.0063X
KCs Certification	18-KA2B0-0212~9X, 18-KA2B0-0236~9X
INMETRO Certification	1DNV 21.0149X
Code of Protection	IM2 Ex db Mb, Ex eb Mb II2G Ex db IIC Gb, Ex eb IIC Gb II2D Ex tb IIC Db
Operating Temperature	-60 ° C ~ 110 ° C
Regulation	Zone 1, 2 & 21, 22, Gas Group IIA, IIB, IIC, Dust Group IIIA, IIIB, IIIC
Ingress Protection (Metric) (NPT)	IP 66 / 68 (request in advance if IP68 required) NPT tapered hole : IP66 IP68 (apply non-hardensng grease) Clearance hole : IP66/68 (using IP Washer)
Applicable Cable Specification	Non-armoured cable, Braided armoured cable
Gland Material	Nickel plated brass (standard), Brass (only), Stainless steel (316L)
Gasket (washer)	Nylon (Standard), PTFE-Teflon (Option)
Packing	Silicone
Accessories (optional)	Lock nut, Sealing washer, Earth tag, Serrated washer

I Order Example

Part No.	Thread	Material	Accessories
OS-E1UF-MH 20	M20(M)xM20(F)	Nickel plated brass	Lock nut, Sealing washer, Earth tag, Serrated washer, Shroud

- Optional Thread Length : ≥15mm
- Material for accessories is required

(* in mm)

Part No. (Gland Size)	Entry Thread Size "M" (Metric, NPT, PF)		Entry Thread Size "M1" (Metric, NPT, PF)		Thread Length(ℓ)-Min			Cable Dia(A)	Hexagon Dimensions (HxP)	Length (L)
	Metric	NPT / PF	Metric	NPT / PF	Metric	NPT / PF	Option			
OS-E1UF-MH 16	M16 or M20	1/2"	M16 or M20	1/2"	15	15	15	5.0 ~ 11.5	H35 x P37	46
OS-E1UF-MH 20	M20 or M25	1/2" or 3/4"	M20	1/2"	15	15	16	7.5 ~ 15.2	H35 x P37	48
OS-E1UF-MH 25	M25	3/4" or 1"	M25	3/4"	15	16	18	13.0 ~ 19.6	H41 x P43	51
OS-E1UF-MH 32	M32	1" or 1-1/4"	M32	1"	15	18	19	16.5 ~ 26.2	H50 x P54	56
OS-E1UF-MH 40	M40	1-1/4" or 1-1/2"	M40	1-1/4"	15	19	21	23.0 ~ 32.3	H55 x P59	63
OS-E1UF-MH 50	M50	1-1/2" or 2"	M50	1-1/2"	15	21	24	29.0 ~ 41.5	H70 x P75	70
OS-E1UF-MH 63	M63	2" or 2-1/2"	M63	2"	15	24	27	39.0 ~ 50.0	H77 x P82	77
OS-E1UF-MH 63X	M63	2-1/2"	M63 or M75	2-1/2"	15	27		46.0 ~ 55.0	H90 x P95	77
OS-E1UF-MH 75	M75	2-1/2" or 3"	M75	2-1/2"	20	27	30	52.0 ~ 61.0	H90 x P95	78
OS-E1UF-MH 75X	M75	3"	M75 or M90	3"	20	30		59.0 ~ 67.0	H108 x P113	86
OS-E1UF-MH 90	M90	3" or 3-1/2"	M90	3"	25	30	32	66.0 ~ 80.0	H108 x P113	86
OS-E1UF-MH 100	M100	3-1/2" or 4"	M100 or M115	3-1/2" or 4"	25	32	32	76.0 ~ 90.5	H145 x P150	96
OS-E1UF-MH 115	M115	4"	M115	4"	25	32		88.0 ~ 102.0	H145 x P150	96

※ The entry holes need not greater than 0.7mm ※ Up to M75, 1.5 pitch is standard and from M90, 2.0 pitch is standard

OS-E1UF-MC



Certificates	
Classifications	

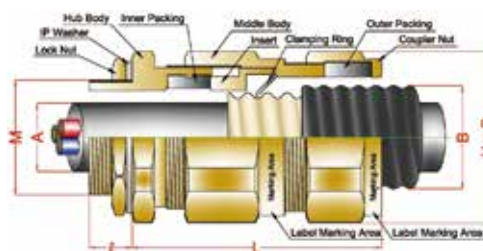

I Application : Metal Clad Type Cable

- For use with Metal clad cable
- Outdoor & Indoor use
- Flameproof & Increased Safety
- EMC cable gland. (360 ° contact) - EMC tested
- Reduce the effect of coldflow characteristics
- Double compression

Design Specification	BS 6121, IEC 62444, EN 50262
Compliance Standard	IEC/EN 60079-0, 1, 7, 31
ATEX Certification	Presafe 17 ATEX 11456X
IECEx Certification	IECEx PRE 17.0063X
KCs Certification	18-KA2BO-0212~9X, 0236~9X
Code of Protection	IM2 Ex db I Mb, Ex eb I Mb II2G Ex db IIC Gb, Ex eb IIC Gb, II2D Ex tb IIC Db
Operating Temperature	-60 ° C ~ 110 ° C
Regulation	Zone 1,2 & 21,22, Gas Group IIA, IIB, IIC, Dust Group IIIA, IIIB, IIIC
Ingress Protection (Metric) (NPT)	IP 66 / 68 (request in advance if IP68 required) NPT tapered hole : IP66 IP68(apply non-hardening grease) Clearance hole : IP66/68(using IP Washer)
Applicable Cable Specification	Metal clad cable
Gland Material	Nickel plated brass(standard), Brass(only), Stainless steel(316L), Aluminum
Gasket (washer)	Nylon(Standard), PTFE-Teflon(Option)
Packing	Silicone
Accessories (optional)	Lock nut, Sealing washer, Earth tag, Shroud, Serrated washer

I Order Example

Part No.	Thread	Material	Accessories
OS-E1UF-MC 20	M20	Nickel plated brass	Lock nut, Sealing washer, Earth tag, Serrated washer, Shroud

- Optional Thread Length : ≥15mm (Standard : M16 ~ M63 Length 15mm, M75 Length 20mm, M90 ~ M115 Length 25mm)
- Material for accessories is required
- Aluminium material not intended for Group I
- Other than IECEx, ATEX and KCs marking, the marking requirement must be informed when ordered.

(* in mm)

Part No. (Gland Size)	Entry Thread Size(M)			Thread Length(ℓ) -Min			Cable Dia		Hexagon Dimensions	Weight (g)	Length (L)
	Metric	NPT	Option	Metric	NPT	Option	Inner 'A'	Outer 'B'			
OS-E1UF-MC 16	M16	1/2"	M20	15	15	15	5 ~ 11.5	9 ~ 15.5	H25 x P27	137	56
OS-E1UF-MC 20	M20	1/2"	3/4"	15	15	16	7.5 ~ 15.2	13.2 ~ 20.5	H31 x P34	212	63
OS-E1UF-MC 25	M25	3/4"	1"	15	16	18	13 ~ 19.6	17 ~ 26	H37 x P40	325	68
OS-E1UF-MC 32	M32	1"	1-1/4"	15	18	19	16.5 ~ 26.2	24 ~ 33.5	H47 x P50	570	75
OS-E1UF-MC 40	M40	1-1/4"	1-1/2"	15	19	21	23 ~ 32.3	30 ~ 41.5	H56 x P60	876	83
OS-E1UF-MC 50	M50	1-1/2"	2"	15	21	24	29 ~ 41.5	38 ~ 50	H70 x P75	1445	89
OS-E1UF-MC 63	M63	2"		15	24		39 ~ 50	45 ~ 60	H77 x P82	1740	98
OS-E1UF-MC 63X	M63		2-1/2"	15		27	46 ~ 55	55 ~ 66	H82 x P88	1907	98
OS-E1UF-MC 75	M75	2-1/2"		20	27		52 ~ 61	58 ~ 72	H92 x P100	3270	109
OS-E1UF-MC 75X	M75		3"	20		30	59 ~ 67	66.1 ~ 79	H98 x P106	2912	109
OS-E1UF-MC 90	M90	3"	3-1/2"	25	30	32	66 ~ 80	72 ~ 90	H110 x P120	4600	111
OS-E1UF-MC 100	M100	3-1/2"	4"	25	32	32	76 ~ 90.5	84 ~ 101.5	H125 x P135	5500	123
OS-E1UF-MC 115	M115	4"		25	32		88 ~ 102	100 ~ 116	H135 x P143	5500	123

OS-A2F-U

Certificates	
Classifications	

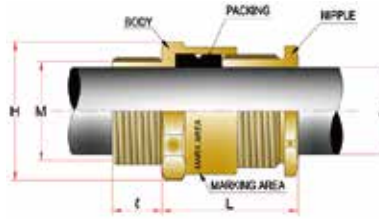

Application : Non-Armoured Cable

- For use with non-armoured & braided armoured cable
- Flameproof & Increased Safety
- Single compression

Design Specification	BS 6121, IEC 62444, EN 50262
Compliance Standard	IEC/EN 60079-0, 1, 7, 31
ATEX Certification	Presafe 17 ATEX 11454X
IECEX Certification	IECEX PRE 17.0062X
KCs Certification	18-KA2BO-0364~71X
TR CU Certification	RU C- KR.AA87.B.01105
PESO Certification	P465223
CCC Certification	2020332313000790
INMETRO Certification	DNV 21.0148X
Code of Protection	II2G Ex db IIC Gb, Ex eb IIC Gb, II2D Ex tb IIIC Db
Operating Temperature	-60 ° C ~ 110 ° C
Regulation	Zone 1,2 & 21,22, Gas Group IIA, IIB, IIC, Dust Group IIIA, IIIB, IIIC
Ingress Protection (Metric) (NPT)	IP 66 / 68 (request in advance if IP68 required) NPT tapered hole : IP66 IP68 (apply non-hardensng grease) Clearance hole : IP66/68 (using IP Washer)
Applicable Cable Specification	Non-armoured cable, Braided amoured cable
Gland Material	Nickel plated brass(standard), Brass(only), Stainless steel(316L)
Gasket (washer)	Nylon(Standard), PTFE-Teflon(Option)
Packing	Silicone
Accessories (optional)	Lock nut, Sealing washer, Earth tag, Shroud, Serrated washer

Order Example

Part No.	Thread	Material	Accessories
OS-A2F-U 20	M20	Nickel plated brass	Lock nut, Sealing washer, Earth tag, Serrated washer, Shroud

- Optional Thread Length : ≥15mm (Standard : M16 ~ M63 Length 15mm, M75 Length 20mm, M90 ~ M115 Length 25mm)
- Material for accessories is required

- Other than IECEX, ATEX and KCs marking, the marking requirement must be informed when ordered.

(* in mm)

Part No.	Entry Thread Size(M)			Thread Length(ℓ) - Min			Cable Dia	Hexagon Dimensions	Weight (g)	Length (L)
	Metric	NPT	Option	Metric	NPT	Option				
OS-A2F-U 16	M16	1/2"	M12/M20	15	15	15	3 ~ 7	H24 x P26	72	29
OS-A2F-U 16X	M16	1/2"	M20	15	15	15	5 ~ 10.3	H24 x P26	72	29
OS-A2F-U 20	M20	1/2"	3/4"	15	15	16	9 ~ 15.3	H27 x P29	79	31
OS-A2F-U 25	M25	3/4"	1"	15	16	18	13 ~ 20	H32 x P34	108	33
OS-A2F-U 32	M32	1"	1-1/4"	15	18	19	17 ~ 26.5	H39 x P41.5	168	36
OS-A2F-U 40	M40	1-1/4"	1-1/2"	15	19	21	22 ~ 32	H48 x P51	272	38
OS-A2F-U 50	M50	1-1/2"	2"	15	21	24	30 ~ 42	H58 x P62	371	41
OS-A2F-U 63	M63	2"		15	24		39 ~ 51	H73 x P78	720	44
OS-A2F-U 63X	M63		2-1/2"	15		27	46 ~ 55	H73 x P78	600	44
OS-A2F-U 75	M75	2-1/2"		20	27		54 ~ 61	H85 x P90	950	48
OS-A2F-U 75X	M75		3"	20		30	58 ~ 68	H94 x P99	1070	49
OS-A2F-U 90	M90	3"	3-1/2"	25	30	32	66 ~ 78	H103 x P109	1480	53
OS-A2F-U 100	M100	3-1/2"	4"	25	32	32	77 ~ 89	H112 x P120	2250	59
OS-A2F-U 115	M115	4"		25	32		88 ~ 101	H125 x P135	2400	59

※ The entry holes need not greater than 0.7mm ※ Up to M75, 1.5 pitch is standard and from M90, 2.0 pitch is standard

OS-A2F-UF



Certificates	
Classifications	

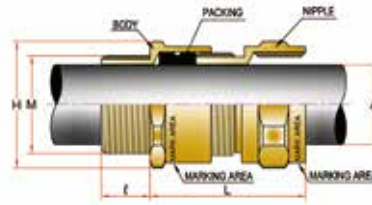

I Application

: Non-Armoured Cable with Male-Female Type

- For use with non-armoured & braided armoured cable
- Male and female threads type
- Flameproof & Increased Safety
- Single compression.
- Flexible conduit provided when requested only (refer to OSEP catalogue cut)

Design Specification	BS 6121, IEC 62444, EN 50262
Compliance Standard	IEC/EN 60079-0, 1, 7, 31
ATEX Certification	Presafe 17 ATEX 11454X
IECEX Certification	IECEX PRE 17.0062X
KCs Certification	18-KA2BO-0364-71X
TR CU Certification	RU C- KR, AA87.B.01105
PESO Certification	P465223
CCC Certification	2020332313000790
INMETRO Certification	DNV 21.0148X
Code of Protection	II2G Ex db IIC Gb, Ex eb IIC Gb, II2D Ex tb IIIC Db
Operating Temperature	-60 ° C ~ 110 ° C
Regulation	Zone 1, 2 & 21, 22, Gas Group IIA, IIB, IIC, Dust Group IIIA, IIIB, IIIC
Ingress Protection (Metric) (NPT)	IP 66 / 68 (request in advance if IP68 required) NPT tapered hole : IP66 IP68(apply non-hardening grease) Clearance hole : IP66/68(using IP Washer)
Applicable Cable Specification	Non-armoured cable, Braided armoured cable
Gland Material	Nickel plated brass(standard), Brass(only), Stainless steel(316L)
Gasket (washer)	Nylon(Standard), PTFE-Teflon(Option)
Packing	Silicone
Accessories (optional)	Lock nut, Sealing washer, Earth tag, Shroud, Serrated washer

I Order Example

Part No.	Thread	Material	Accessories
OS-A2F-UF 20	M20	Nickel plated brass	Lock nut, Sealing washer, Earth tag, Serrated washer, Shroud

- Optional Thread Length : ≥15mm (Standard : M16 ~ M63 Length 15mm, M75 Length 20mm, M90 ~ M115 Length 25mm)
- Material for accessories is required

• Other than IECEx, ATEX and KCs marking, the marking requirement must be informed when ordered.

(* in mm)

Part No. (Gland Size)	Entry Thread Size(M)			Thread Length(ℓ) - Min			Cable Dia	Hexagon Dimensions	Weight (g)	Length (L)
	Metric	NPT	Option	Metric	NPT	Option				
OS-A2F-UF 16	M16	1/2"	M12/M20	15	15	15	3 ~ 7	H24 x P26	79/95	42
OS-A2F-UF 16X	M16	1/2"	M20	15	15	15	5 ~ 10.3	H24 x P26	79/95	42
OS-A2F-UF 20	M20	1/2"	3/4"	15	15	16	9 ~ 15.3	H27 x P29	95	46
OS-A2F-UF 25	M25	3/4"	1"	15	16	18	13 ~ 20	H32 x P34	125	48
OS-A2F-UF 32	M32	1"	1-1/4"	15	18	19	17 ~ 26.5	H39 x P41.5	195	52
OS-A2F-UF 40	M40	1-1/4"	1-1/2"	15	19	21	22 ~ 32	H48 x P51	300	55
OS-A2F-UF 50	M50	1-1/2"	2"	15	21	24	30 ~ 42	H58 x P62	425	61
OS-A2F-UF 63	M63	2"		15	24		39 ~ 51	H73 x P78	680	64
OS-A2F-UF 63X	M63		2-1/2"	15		27	46 ~ 55	H73 x P78	575	64
OS-A2F-UF 75	M75	2-1/2"		20	27		54 ~ 61	H85 x P90	875	69
OS-A2F-UF 75X	M75		3"	20		30	58 ~ 68	H94 x P99	860	71
OS-A2F-UF 90	M90	3"	3-1/2"	25	30	32	66 ~ 78	H103 x P109	1690	77
OS-A2F-UF 100	M100	3-1/2"	4"	25	32	32	77 ~ 89	H112 x P120	2250	84
OS-A2F-UF 115	M115	4"		25	32		88 ~ 101	H125 x P135	2400	84

※ The entry holes need not greater than 0.7mm ※ Up to M75, 1.5 pitch is standard and from M90, 2.0 pitch is standard

OS-A2F-UD

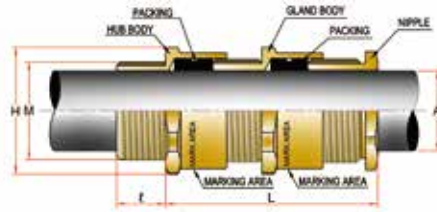

Certificates	
Classifications	

Application : Non-Armoured Cable with Double Compression

- For use with non-armoured & braided armoured cable
- Flameproof & Increased Safety.
- Double compression

Design Specification	BS 6121, IEC 62444, EN 50262
Compliance Standard	IEC/EN 60079-0, 1, 7, 31
ATEX Certification	Presafe 17 ATEX 11454X
IECEx Certification	IECEx PRE 17.0062X
KCs Certification	18-KA2BO-0364~71X
TR CU Certification	RU C- KR.AA87.B.01105
PESO Certification	P465223
CCC Certification	2020332313000790
INMETRO Certification	DNV 21.0148X
Code of Protection	II2G Ex db IIC Gb, Ex eb IIC Gb, II2D Ex tb IIIC Db
Operating Temperature	-60 ° C ~ 110 ° C
Regulation	Zone 1,2 & 21,22, Gas Group IIA, IIB, IIC, Dust Group IIIA, IIIB, IIIC
Ingress Protection (Metric) (NPT)	IP 66 / 68 (request in advance if IP68 required) NPT tapered hole : IP66 IP68(apply non-hardensng grease) Clearance hole : IP66/68(using IP Washer)
Applicable Cable Specification	Non-armoured cable, Braided amoured cable
Gland Material	Nickel plated brass(standard), Brass(only), Stainless steel(316L)
Gasket (washer)	Nylon(Standard), PTFE-Teflon(Option)
Packing	Silicone
Accessories (optional)	Lock nut, Sealing washer, Earth tag, Shroud, Serrated washer

Order Example

Part No.	Thread	Material	Accessories
OS-A2F-UD	M20	Nickel plated brass	Lock nut, Sealing washer, Earth tag, Serrated washer, Shroud

- Optional Thread Length : ≥15mm (Standard : M16 ~ M63 Length 15mm, M75 Length 20mm, M90 ~ M115 Length 25mm)
- Material for accessories is required

- Other than IECEx, ATEX and KCs marking, the marking requirement must be informed when ordered.

(* in mm)

Part No. (Gland Size)	Entry Thread Size(M)			Thread Length(ℓ) - Min			Cable Dia	Hexagon Dimensions	Length (L)
	Metric	NPT	Option	Metric	NPT	Option			
OS-A2F-UD 16	M16	1/2"	M12/M20	15	15	15	3 ~ 7	H24 x P26	53
OS-A2F-UD 16X	M16	1/2"	M20	15	15	15	5 ~ 10.3	H24 x P26	53
OS-A2F-UD 20	M20	1/2"	3/4"	15	15	16	9 ~ 15.3	H27 x P29	58
OS-A2F-UD 25	M25	3/4"	1"	15	16	18	13 ~ 20	H32 x P34	61
OS-A2F-UD 32	M32	1"	1-1/4"	15	18	19	17 ~ 26.5	H39 x P41.5	67
OS-A2F-UD 40	M40	1-1/4"	1-1/2"	15	19	21	22 ~ 32	H48 x P51	72
OS-A2F-UD 50	M50	1-1/2"	2"	15	21	24	30 ~ 42	H58 x P62	77
OS-A2F-UD 63	M63	2"		15	24		39 ~ 51	H73 x P78	82
OS-A2F-UD 63X	M63		2-1/2"	15		27	46 ~ 55	H73 x P78	82
OS-A2F-UD 75	M75	2-1/2"		20	27		54 ~ 61	H85 x P90	89
OS-A2F-UD 75X	M75		3"	20		30	58 ~ 68	H94 x P99	92
OS-A2F-UD 90	M90	3"	3-1/2"	25	30	32	66 ~ 78	H103 x P109	98
OS-A2F-UD 100	M100	3-1/2"	4"	25	32	32	77 ~ 89	H112 x P120	108
OS-A2F-UD 115	M115	4"		25	32		88 ~ 101	H125 x P135	116

※ The entry holes need not greater than 0.7mm ※ Up to M75, 1.5 pitch is standard and from M90, 2.0 pitch is standard

OS-A2F-UH

Certificates	
Classifications	

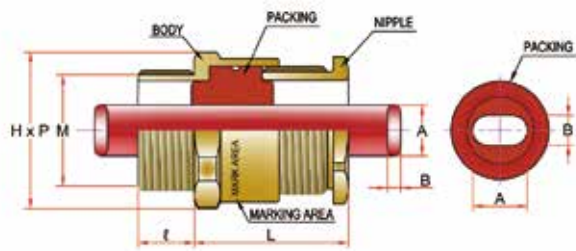

Application : Heat Tracing / Flat Form Cable

- For use with flat form non-armoured & braided armoured cable
- Increased safety
- Suitable for heat tracing / flat form cable
- Single compression

Design Specification	BS 6121, IEC 62444, EN 50262
Compliance Standard	IEC/EN 60079-0, 1, 7, 31
ATEX Certification	Presafe 17 ATEX 11486X
IECEX Certification	IECEX PRE 17.0083X
KCs Certification	18-KA2BO-0220~1X
TR CU Certification	RU C- KR.AA87.B.01105
PESO Certification	P465223
CCC Certification	2020332313001772
INMETRO Certification	DNV 21.0150X
Code of Protection	II2G Ex eb IIC Gb, II2D Ex tb IIIC Db
Operating Temperature	-60°C ~121 ° C
Regulation	Zone 1,2 & 21,22, Gas Group IIA, IIB, IIC, Dust Group IIIA, IIIB, IIIC
Ingress Protection	IP 66
Applicable Cable Specification	Heating cable
Gland Material	Nickel plated brass(standard), Brass(Only), Stainless steel(316L)
Gasket (washer)	Nylon(Standard), PTFE-Teflon(Option)
Packing	Silicone
Accessories (optional)	Lock nut, Sealing washer, Earth tag, Shroud, Serrated washer

Order Example

Part No.	Thread	Material	Accessories
OS-A2F-UH 20	M20	Nickel plated brass	Lock nut, Sealing washer, Earth tag

- Optional Thread Length: ≥15mm
- Material for accessories is required
- Other than IECEX, ATEX and KCs marking, the marking requirement must be informed when ordered.

20 type packing size

Size	Dimension	
	A	B
A	12	5
B	13	6.5
C	14	6
D	15	6.5
F	12	7.5

25 type packing size

Size	Dimension	
	A	B
A	12	5
B	13	6.5
C	14	6
D	15	6.5
E	16.5	7
F	12	7.5

(* in mm)

Part No. (Gland Size)	Entry Thread Size(M)			Thread Length(ℓ)-Min			Cable Dia		Hexagon Dimensions	Weight (g)	Length (L)
	Metric	NPT	Option	Metric	NPT	Option	A	B			
OS-A2F-UH 20	M20	1/2"		15	15		11 ~ 15	4.5 ~ 8	H32 x P34	125	48
OS-A2F-UH 25	M25	3/4"	1"	15	16	18	11 ~ 16.5	4.5 ~ 8	H32 x P34	110	48

※ The entry holes need not greater than 0.7mm

OS-A2F-UHMH

Certificates	
Classifications	

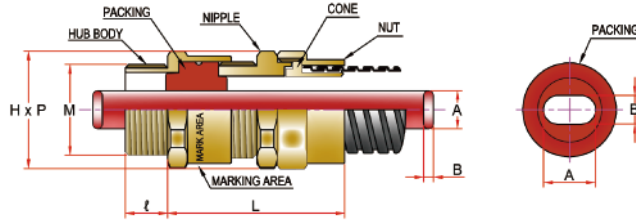

I Application

: Heat Tracing / Flat Form Cable with Metal Hose

- For use with flat form non-armoured & braided armoured cable
- Increased Safety
- Suitable for Heat Tracing / Flat Form Cable
- Single Compression

Design Specification	BS 6121, IEC 62444, EN 50262
Compliance Standard	IEC/EN 60079-0, 1, 7, 31
ATEX Certification	Presafe 17 ATEX 11486X
IECEX Certification	IECEX PRE 17.0083X
KCs Certification	18-KA2BO-0364~71X
TR CU Certification	RU C- KR.AA87.B.01105
PESO Certification	P465223
CCC Certification	2020332313001772
INMETRO Certification	DNV 21.0150X
Code of Protection	II2G Ex eb IIC Gb, II2D Ex tb IIIC Db
Operating Temperature	-60°C ~121 °C
Regulation	Zone 1,2 & 21,22, Gas Group IIA, IIB, IIC, Dust Group IIIA, IIIB, IIIC
Ingress Protection	IP 66
Applicable Cable Specification	Heating cable
Gland Material	Nickel plated brass(standard), Brass(Only), Stainless steel(316L)
Gasket (washer)	Nylon(Standard), PTFE-Teflon(Option)
Packing	Silicone
Accessories (optional)	Lock nut, Sealing washer, Earth tag, Shroud, Serrated washer

I Order Example

Part No.	Thread	Material	Accessories
OS-A2F-UHMH 20	M20	Nickel plated brass	Lock nut, Sealing washer, Earth tag, Serrated washer, Shroud

- Optional Thread Length : ≥15mm
- Material for accessories is required
- Other than IECEX, ATEX and KCs marking, the marking requirement must be informed when ordered.

20 type packing size

Size	Dimension	
	A	B
A	12	5
B	13	6.5
C	14	6
D	15	6.5
F	12	7.5

25 type packing size

Size	Dimension	
	A	B
A	12	5
B	13	6.5
C	14	6
D	15	6.5
E	16.5	7
F	12	7.5

(* in mm)

Part No. (Gland Size)	Entry Thread Size(M)			Thread Length(ℓ)-Min			Cable Dia		Hexagon Dimensions	Weight (g)	Length (L)
	Metric	NPT	Option	Metric	NPT	Option	A	B			
OS-A2F-UHMH 20	M20	1/2"		15	15		11 ~ 15	4.5 ~ 8	H36 x P39	125	48
OS-A2F-UHMH 25	M25	3/4"	1"	15	16	18	11 ~ 16.5	4.5 ~ 8	H36 x P39	110	48

※ The entry holes need not greater than 0.7mm

OS-A2F-UMH



Certificates	
Classifications	

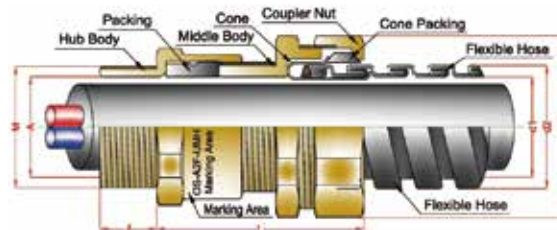

I Application : Non-armoured Cable with Metal Hose Type

- For use with non-armoured & braided armoured cable
- Flameproof & Increased Safety
- Suitable for metal hose
- Single compression

Design Specification	BS 6121, IEC 62444, EN 50262
Compliance Standard	IEC/EN 60079-0, 1, 7, 31
ATEX Certification	Presafe 17 ATEX 11454X
IECEX Certification	IECEX PRE 17.0062X
KCs Certification	18-KA2B0-0364-71X
TR CU Certification	RU C- KR.AA87.B.01105
PESO Certification	P465223
CCC Certification	2020332313000790
INMETRO Certification	DNV 21.0148X
Code of Protection	II2G Ex db IIC Gb, Ex eb IIC Gb, II2D Ex tb IIIC Db
Operating Temperature	-60 °C ~ 110 °C
Regulation	Zone 1, 2 & 21, 22, Gas Group IIA, IIB, IIC, Dust Group IIIA, IIIB, IIIC
Ingress Protection (Metric) (NPT)	IP 66 / 68 (request in advance if IP68 required) NPT tapered hole : IP66 IP68 (apply non-hardening grease) Clearance hole : IP66/68 (using IP Washer)
Applicable Cable Specification	Non-armoured cable, Braided armoured cable
Gland Material	Nickel plated brass (standard), Brass (only), Stainless steel (316L)
Gasket (washer)	Nylon (Standard), PTFE-Teflon (Option)
Packing	Silicone
Accessories (optional)	Lock nut, Sealing washer, Earth tag, Shroud, Serrated washer

I Order Example

Part No.	Thread	Material	Accessories
OS-A2F-UMH 20	M20	Nickel plated brass	Lock nut, Sealing washer, Serrated washer

- Optional Thread Length: ≥15mm (Standard: M16-M63 Length 15mm, M75 Length 20mm, M90-M115 Length 25mm)
- Material for accessories is required

- Other than IECEX, ATEX and KCs marking, the marking requirement must be informed when ordered.

(* in mm)

Part No. (Gland Size)	Entry Thread Size(M)			Thread Length(ℓ)-Min			Cable Dia	Metal Hose Dia		Hexagon Dimensions (H x P)	Length (L)
	Metric	NPT	Option	Metric	NPT	Option		In Dia(d1)	Out Dia(d2)		
OS-A2F-UMH 16(F16)	M16	1/2"	M20	15	15	15	3.0 ~ 7.0	15.5	21.0	H30 x P32	46
OS-A2F-UMH 16X(F16)	M16	1/2"	M20	15	15	15	5.0 ~ 10.3	15.5	21.0	H30 x P32	46
OS-A2F-UMH 20(F16)	M20	1/2"	3/4"	15	15	16	9.0 ~ 15.3	15.5	21.0	H30 x P32	49
OS-A2F-UMH 25(F22)	M25	3/4"	1"	15	16	18	13.0 ~ 20.0	20.0	27.0	H36 x P39	50
OS-A2F-UMH 32(F28)	M32	1"	1-1/4"	15	18	19	17.0 ~ 26.5	26.0	33.0	H45 x P48	55
OS-A2F-UMH 40(F36)	M40	1-1/4"	1-1/2"	15	19	21	22.0 ~ 32.0	34.0	43.0	H56 x P60	58
OS-A2F-UMH 50(F42)	M50	1-1/2"	2"	15	21	24	30.0 ~ 42.0	39.0	48.0	H58 x P62	63
OS-A2F-UMH 63(F54)	M63	2"	2-1/2"	15	24	27	39.0 ~ 51.0	49.0	60.0	H73 x P78	67
OS-A2F-UMH 63X(F70)	M63		2-1/2"	15		27	46.0 ~ 55.0	63.0	74.0	H85 x P90	70
OS-A2F-UMH 75(F70)	M75	2-1/2"	3"	20	27	30	54.0 ~ 61.0	63.0	74.0	H85 x P90	74
OS-A2F-UMH 75X(F82)	M75		3"	20		30	58.0 ~ 68.0	76.0	91.0	H103 x P109	84
OS-A2F-UMH 90(F82)	M90	3"	3-1/2"	25	30	32	66.0 ~ 78.0	76.0	91.0	H103 x P109	85
OS-A2F-UMH 100(F104)	M100	3-1/2"	4"	25	32	32	77.0 ~ 89.0	90.0	108.0	H125 x P135	91
OS-A2F-UMH 115(F104)	M115	4"	4"	25	32		88.0 ~ 101.0	90.0	108.0	H125 x P135	95

※ The entry holes need not greater than 0.7mm

OS-A2F-UEP



Certificates	
Classifications	

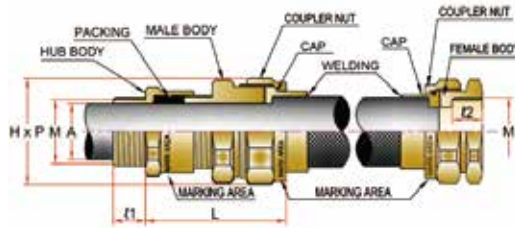

Application

: Non-Armoured Cable with Flexible Conduit Type

- For use with non-armoured & braided armoured cable
- Used in narrow space or complicated area which requires flexibility
- Flameproof & Increased Safety
- Single compression
- Flexible conduit alone cannot be certified

Design Specification	BS 6121, IEC 62444, EN 50262
Compliance Standard	IEC/EN 60079-0, 1, 7, 31
ATEX Certification	Presafe 17 ATEX 11454X
IECEX Certification	IECEX PRE 17.0062X
KCs Certification	18-KA2B0-0364-71X
TR CU Certification	RU C- KR.AA87.B.01105
PESO Certification	P465223
CCC Certification	2020332313000790
INMETRO Certification	DNV 21.0148X
Code of Protection	II2G Ex db IIC Gb, Ex eb IIC Gb, II2D Ex tb IIIC Db
Operating Temperature	-60 ° C ~ 110 ° C
Regulation	Zone 1, 2 & 21, 22, Gas Group IIA, IIB, IIC, Dust Group IIIA, IIIB, IIIC
Ingress Protection (Metric) (NPT)	IP 66 / 68 (request in advance if IP68 required) NPT tapered hole : IP66 IP68 (apply non-hardensng grease) Clearance hole : IP66/68(using IP Washer)
Applicable Cable Specification	Non-armoured cable, Braided armoured cable
Thread Available	Male and Female type Male and Male type Female and Female type
Gland Material	Nickel plated brass(standard), Brass(only), Stainless steel(316L)
Flexible Material	Stainless steel(304, 316L)
Gasket (washer)	Nylon(Standard), PTFE-Teflon(Option)
Packing	Silicone
Accessories (optional)	Lock nut, Sealing washer, Earth tag, Shroud, Serrated washer

Order Example

Part No.	Thread	Flexible (mm)	Material	Accessories
OS-A2F-UEP 20(F16)	M20(M) X M20(F)	300≤	Nickel plated brass	Lock nut, Sealing washer, Serrated washer

- Optional Thread Length : ≥15mm
- Material for accessories is required
- Other than IECEX, ATEX and KCs marking, the marking requirement must be informed when ordered.

(* in mm)

Part No. (Gland Size)	Entry Thread Size(M1, M2)			Thread Length(L) - Min			Cable Dia(A) Waterproof	Hexagon Dimensions (H x P)	Length(L)	
	Metric	NPT	Option	Metric	NPT	Option			Gland	Flexible
OS-A2F-UEP 16(F16)	M16	1/2"	M20	15	15	15	3.0~7.0	H35 x P37	31	Standard 500mm 700mm 1000mm ≤
OS-A2F-UEP 16X(F16)	M16	1/2"	M20	15	15	15	5.0~10.3	H35 x P37	31	
OS-A2F-UEP 20(F16)	M20	1/2"	3/4"	15	15	16	9.0~13.0	H35 x P37	33	
OS-A2F-UEP 25(F22)	M25	3/4"	1"	15	16	18	13.0~18.0	H41 x P43	34	
OS-A2F-UEP 32(F28)	M32	1"	1-1/4"	15	18	19	17.0~24.5	H50 x P54	38	
OS-A2F-UEP 40(F36)	M40	1-1/4"	1-1/2"	15	19	21	22.0~31.0	H60 x P63	40	
OS-A2F-UEP 50(F42)	M50	1-1/2"	2"	15	21	24	30.0~36.5	H67 x P70	42	
OS-A2F-UEP 50(F54)	M50	1-1/2"	2"	15	21	24	34~42	H80 x P83	46	
OS-A2F-UEP 63(F54)	M63	2"		15	24		39~49	H80 x P83	46	
OS-A2F-UEP 63X(F70)	M63		2-1/2"	15		27	46~55	H96 x P101	46	
OS-A2F-UEP 75(F70)	M75	2-1/2"		20	27		54~61	H96 x P101	52	
OS-A2F-UEP 75X(F82)	M75		3"	20		30	58~68	H108 x P113	52	
OS-A2F-UEP 90(F82)	M90	3"	3-1/2"	25	30	32	66~78	H108 x P113	60	
OS-A2F-UEP 100(F104)	M100	3-1/2"	4"	25	32	32	77~89	H145 x P150	69	

※ The entry holes need not greater than 0.7mm ※ Up to M75, 1.5 pitch is standard and from M90, 2.0 pitch is standard

OSXP-F

Certificates

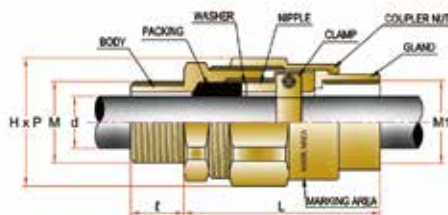

Application : Cable Packing Type

- For use with pipe connection or machine
- Flameproof & Increased Safety
- Single compression
- Male and Female threads type

Compliance Standard	KS IEC 60079-0, 1, 7, 31
KCS Certification	16, 22, 28 : 10-AV2BO-0416X
	36, 42, 54 : 10-AV2BO-0479X
	70, 82, 104 : 10-AV2BO-0417X
Code of Protection	Ex e II, Ex d IIC
Ingress Protection	IP 66 / 67
Gland Material	Nickel plated brass(Standard), Stainless steel(316L)
Gasket (washer)	EPDM
Packing	Silicone
Accessories (optional)	Lock nut, Sealing washer, Earth tag, Serrated washer

Order Example

Part No.	Thread	Material	Accessories
OSXP-F 16	NPT 1/2"	Nickel plated brass	Lock nut, Sealing washer, Earth tag

- Material for accessories is required
- Cable diameter must be informed when order.

(* in mm)

Part No. (Gland Size)	Entry Thread Size(M)		Thread Length(ℓ) - Min		Cable Dia			Hexagon Dimensions	Length (L)
	Metric	NPT/PF/PT	Metric	NPT/PF/PT	Standard	Option			
						A	B		
OSXP-F 16	M20	1/2"	15	16	9 ~ 13	6 ~ 10	10 ~ 14	H32 x P34	65
OSXP-F 22	M25	3/4"	15	17	14 ~ 16	15 ~ 18		H38 x P41	71
OSXP-F 28	M32	1"	15	18	18 ~ 21	19 ~ 22		H45 x P48	74
OSXP-F 36	M40	1-1/4"	15	20	22 ~ 26	26 ~ 28		H53 x P57	82
OSXP-F 42	M50	1-1/2"	15	22	29 ~ 32	31 ~ 35		H60 x P64	84
OSXP-F 54	M63	2"	15	24	40 ~ 44	35 ~ 40	42 ~ 45	H73 x P78	90
OSXP-F 70	M75	2-1/2"	20	26	50 ~ 54	45 ~ 50	52 ~ 56	H90 x P96	100
OSXP-F 82	M90	3"	25	31	60 ~ 64	56 ~ 60	64 ~ 74	H102 x P109	108
OSXP-F 104	M100	4"	25	33	80 ~ 86	74 ~ 80	80 ~ 88	H130 x P136	112

※ The entry holes need not greater than 0.7mm ※ ※ Up to M75, 1.5 pitch is standard and from M90, 2.0 pitch is standard

OSER-Z

Certificates	
Classifications	

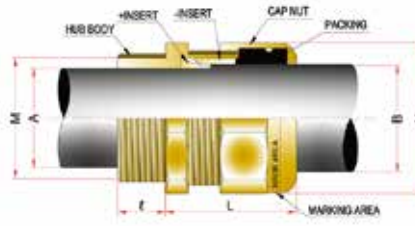

Application : Any Type of Armoured Cable(touch)

- For use with braid armoured cable
- Outdoor & Indoor use
- Touch type
- EMC cable gland (360 ° contact)
- Increased safety
- Single compression
- Reduce the effect of coldflow characteristics

Design Specification	BS 6121, IEC 62444, EN 50262
Compliance Standard	IEC/EN 60079-0, 7, 31
ATEX Certification	Presafe 17 ATEX 11342X
IECEX Certification	IECEX PRE 17.0060X
KCs Certification	18-KA2BO-0202-5X
TR CU Certification	RU C- KR.AA87.B.01105
PESO Certification	P465223
CCC Certification	2020332313000791
INMETRO Certification	DNV 21.0147X
Code of Protection	II2G Ex eb IIC Gb, II2D Ex tb IIIC Db
Operating Temperature	-60 ° C ~ 130 ° C
Regulation	Zone 1,2 & 21,22, Gas Group IIA, IIB, IIC, Dust Group IIIA, IIIB, IIIC
Ingress Protection (Metric) (NPT)	IP 66 / 68 (request in advance if IP68 required) NPT tapered hole : IP66 IP68(apply non-hardening grease) Clearance hole : IP66/68(using IP Washer)
Applicable Cable Specification	Any types of armoured cable
Gland Material	Nickel plated brass(standard), Brass(only), Stainless steel(316L)
Gasket (washer)	Nylon(Standard), PTFE-Teflon(Option)
Packing	Silicone
Accessories (optional)	Lock nut, Sealing washer, Earth tag

Order Example

Part No.	Thread	Material	Accessories
OSER-Z 16	M20	Nickel plated brass	Lock nut ,Sealing washer, Earth tag, Serrated washer, Shroud

- Material for accessories is required
- Other than IECEx, ATEX and KCs marking, the marking requirement must be informed when ordered.

(* in mm)

Part No. (Gland Size)	Entry Thread Size(M)			Thread Length(ℓ) - Min			Cable Dia (B)	Hexagon Dimensions	Weight (g)	Length (L)
	Metric	NPT	Option	Metric	NPT	Option				
OSER-Z 16	M16	1/2"	M20	15	15	15	5 ~ 11.5	H21 x P23	68	30
OSER-Z 20	M20	1/2"	M25 3/4"	15	15	15/16	9 ~ 16.0	H25 x P27	75	32
OSER-Z 25S	M20	1/2"		15	15		13 ~ 17.5	H31 x P33	130	36
OSER-Z 25	M25	3/4"	1"	15	16	18	14 ~ 20	H31 x P33	130	36
OSER-Z 32	M32	1"	1-1/4"	15	18	19	20 ~ 26	H37 x P40	190	40
OSER-Z 40	M40	1-1/4"	1-1/2"	15	19	21	25 ~ 34	H47 x P50	294	41
OSER-Z 50	M50	1-1/2"	2"	15	21	24	33 ~ 42	H56 x P60	393	44
OSER-Z 63	M63	2"	2-1/2"	15	24	27	42 ~ 52	H70 x P75	742	47

※ OSER-ZWC will exclude will the size
 ※ The entry holes need not greater than 0.7mm

OSER-ZN

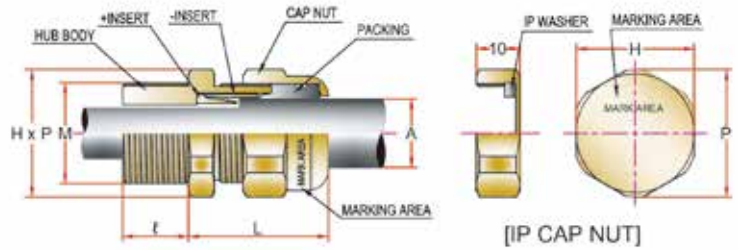

Certificates	CE, ATEX, IECEx, INMETRO
Classifications	IP66/68

Application

: Non-armoured cable and Any Type of Armoured Cable(touch)

- For use with non-armoured & braided armoured cable
- Outdoor & Indoor use
- Touch type
- EMC cable gland (360 ° contact)
- Increased safety
- Single compression
- Reduce the effect of coldflow characteristics
- IP Cap nut available for quick additional termination(IP 66)

Design Specification	BS 6121, IEC 62444, EN 50262
Compliance Standard	IEC/EN 60079-0, 7, 31
ATEX Certification	Presafe 17 ATEX 11342X
IECEX Certification	IECEX PRE 17.0060X
KCs Certification	21-KA2BO-0000-0000X(Certification scheduled)
INMETRO Certification	DNV 21.0147X
Code of Protection	II2G Ex eb IIC Gb, II2D Ex tb IIIC Db
Operating Temperature	-60 ° C ~ 110 ° C
Regulation	Zone 1,2 & 21,22, Gas Group IIA, IIB, IIC, Dust Group IIIA, IIIB, IIIC
Ingress Protection	IP 66/68
Applicable Cable Specification	Non-armoured cable, Any type of armoured cable
Gland Material	Nickel plated brass(standard), Brass(only), Stainless steel(316L)
Gasket (washer)	Nylon(Standard), PTFE-Teflon(Option)
Packing	Silicone
Accessories (optional)	Lock nut, Sealing washer, Earth tag

Order Example

Part No.	Thread	Material	Accessories
OSER-ZN 20	M20	Nickel plated brass	Lock nut, Sealing washer, Earth tag, IP Cap Nut

* Material for accessories is required

(* in mm)

Part No.	Entry Thread Size(M)			Thread Length(ℓ) - Min			Cable Dia	Hexagon Dimensions	Weight (g)	Length (L)
	Metric	NPT	Option	Metric	NPT	Option				
OSER-ZN 20	M20	1/2"	M25 3/4"	15	15	16	8.7 ~ 16.0	H30 x P32	134	32
OSER-ZN 25	M25	1/2"	1"	15	16	18	13.0 ~ 21.0	H32 x P34	146	36

※ The entry holes need not greater than 0.7mm

※ Option item (IP Cap Nut)

Part No. (IP Cap Nut Size)	Hexagon Dimensions (HxP)	Length (L)
IP Cap Nut 20	H30 x P32	10
IP Cap Nut 25	H32 x P34	10

OSER-CS

Certificates	
Classifications	

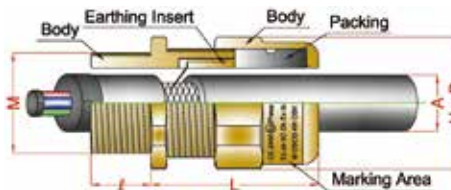

Application : For any types of Braided / Screened cables

- For use with braid armoured cable
- Outdoor & Indoor use
- Contact around screen circumference
- EMC cable gland (360°contact)
- Increased safety
- Single compression
- Reduce the effect of coldflow characteristics
- Easy installation, especially for lighting

Design Specification	BS 6121, IEC 62444, EN 50262
Compliance Standard	IEC/EN 60079-0, 7, 31
ATEX Certification	DNV 22 ATEX 69825X
IECEX Certification	IECEX DNV 22.0080X
KCs Certification	22-KA2BO-0000-0X(Certification scheduled)
Code of Protection	II2G Ex eb IIC Gb, II2D Ex tb IIIC Db
Operating Temperature	-60 ° C ~ 130 ° C
Regulation	Zone 1,2 & 21,22, Gas Group IIA, IIB, IIC, Dust Group IIIA, IIIB, IIIC
Ingress Protection (Metric)	IP 66 / 68
(NPT)	NPT tapered hole : IP66 IP68(apply non-hardening grease) Clearance hole : IP66/68(using IP Washer)
Applicable Cable Specification	Any types of braided / screened cable
Gland Material	Nickel plated brass(standard), Brass(only), Stainless steel(316L)
Gasket (washer)	Nylon
Packing	Silicone
Accessories (optional)	Lock nut, Sealing washer, Earth tag

Order Example

Part No.	Thread	Material	Accessories
OSER-CS 25	M25	Nickel plated brass	Lock nut ,Sealing washer, Earth tag, Serrated washer

- Material for accessories is required
- Other than IECEX, ATEX and KCs marking, the marking requirement must be informed when ordered.

(* in mm)

Part No. (Gland Size)	Entry Thread Size(M)			Thread Length(ℓ) - Min			Cable Dia (A)	Hexagon Dimensions (H x P)	Weight (g)	Length (L)
	Metric	NPT	Option	Metric	NPT	Option				
OSER-CS 25	M25	3/4"	1"	15	16	18	8 ~ 17	H31 x P33	130	42

※ The entry holes need not greater than 0.7mm

OS-E1U

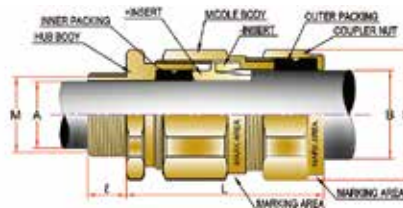

I Application : Any Type of Armoured Cable

- For use with any type of armoured cable
- Outdoor & Indoor use
- Weatherproof & Waterproof
- EMC cable gland. (360° contact) - EMC tested
- Reduce the effect of coldflow characteristics
- Double compression

Design Specification	BS 6121, IEC 62444, EN 50262
Ingress Protection (Metric)	IP 66 / 68 (request in advance if IP68 required)
(NPT)	NPT tapered hole : IP66 IP68 (apply non-hardening grease)
	Clearance hole : IP66/68 (using IP Washer)
Applicable Cable Specification	All types of armoured cable
Gland Material	Nickel plated brass (standard), Brass (only), Stainless steel (316L), Aluminum
Gasket (washer)	Nylon (Standard), PTFE-Teflon (Option)
Packing	Silicone
Accessories (optional)	Lock nut, Sealing washer, Earth tag, Shroud, Serrated washer

I Order Example

Part No.	Thread	Material	Accessories
OS-E1U	M20	Nickel plated brass	Lock nut, Sealing washer, Earth tag, Serrated washer, Shroud

- Optional Thread Length: ≥15mm (Standard: M16-63 Length 15mm, M75 length 20mm, M90 - M115 Length 25mm)
- Material for accessories is required

BS 6121 Type of Gland (The suffix for each type of protection)

		Wire armoured Position	Braid armoured Position
Single wire armoured	W		
Wire braided	X		
Aluminium strip armoured	Y		
Double steel tape armoured	Z		

(* in mm)

Part No. (Gland Size)	Entry Thread Size (M)			Thread Length (ℓ) - Min			Cable Dia		Armour Size		Hexagon Dimensions	Weight (g)	Length (L)
	Metric	NPT	Option	Metric	NPT	Option	Inner 'A'	Outer 'B'	Wire	Braid			
OS-E1U 16	M16	1/2"	M20	15	15	15	5 ~ 11.5	9 ~ 15.5	0.9 ~ 1.25	0.05 ~ 0.8	H25 x P27	137	58
OS-E1U 20	M20	1/2"	3/4"	15	15	16	7.5 ~ 15.2	13.2 ~ 20.5	0.9 ~ 1.25	0.05 ~ 0.8	H31 x P34	212	66
OS-E1U 25	M25	3/4"	1"	15	16	18	13 ~ 19.6	17 ~ 26	1.25 ~ 1.6	0.05 ~ 0.8	H37 x P40	325	68
OS-E1U 32	M32	1"	1-1/4"	15	18	19	16.5 ~ 26.2	24 ~ 33.5	1.6 ~ 2.0	0.05 ~ 1.2	H47 x P50	570	75
OS-E1U 40	M40	1-1/4"	1-1/2"	15	19	21	23 ~ 32.3	30 ~ 41.5	1.6 ~ 2.0	0.05 ~ 1.2	H56 x P60	876	86
OS-E1U 50	M50	1-1/2"	2"	15	21	24	29 ~ 41.5	38 ~ 50	1.8 ~ 2.5	0.05 ~ 1.2	H70 x P75	1445	93
OS-E1U 63	M63	2"		15	24		39 ~ 50	45 ~ 60	1.8 ~ 2.5	0.05 ~ 1.2	H77 x P82	1740	103
OS-E1U 63X	M63		2-1/2"	15		27	46 ~ 55	55 ~ 66	1.8 ~ 2.5	0.05 ~ 1.2	H82 x P88	1907	104
OS-E1U 75	M75	2-1/2"		20	27		52 ~ 61	58 ~ 72	1.8 ~ 2.5	0.05 ~ 1.2	H92 x P100	3270	110
OS-E1U 75X	M75		3"	20		30	59 ~ 67	66.1 ~ 79	1.8 ~ 2.5	0.05 ~ 1.2	H98 x P106	2912	113
OS-E1U 90	M90	3"	3-1/2"	25	30	32	66 ~ 80	72 ~ 90	1.8 ~ 3.0	0.05 ~ 1.6	H110 x P120	4600	128
OS-E1U 100	M100	3-1/2"	4"	25	32	32	76 ~ 90.5	84 ~ 101.5	1.8 ~ 3.0	0.05 ~ 1.6	H125 x P135	5500	134
OS-E1U 115	M115	4"		25	32		88 ~ 102	100 ~ 116	1.8 ~ 3.0	0.05 ~ 1.6	H135 x P143	5500	141

※ The entry holes need not greater than 0.7mm ※ Up to M75, 1.5 pitch is standard and from M90, 2.0 pitch is standard

OS-E1U/LS

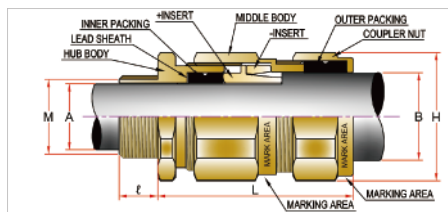

I Application

: Any Type of Lead Sheathed Armoured Cable

- For use with any type of lead sheathed armoured cable
- Outdoor & Indoor use
- Weatherproof & Waterproof
- EMC cable gland. (360 ° contact) - EMC tested
- Reduce the effect of coldflow characteristics
- Double compression

Design Specification	BS 6121, IEC 62444, EN 50262
Ingress Protection (Metric)	IP 66 / 68 (request in advance if IP68 required)
(NPT)	NPT tapered hole : IP66 IP68(apply non-hardening grease) Clearance hole : IP66/68(using IP Washer)
Applicable Cable Specification	All types of armoured cable
Gland Material	Nickel plated brass(standard), Brass(only), Stainless steel(316L)
Gasket (washer)	Nylon(Standard), PTFE-Teflon(Option)
Packing	Silicone
Accessories (optional)	Lock nut, Sealing washer, Earth tag, Shroud, Serrated washer

I Order Example

Part No.	Thread	Material	Accessories
OS-E1U/LS 20	M20	Nickel plated brass	Lock nut Sealing washer, Earth tag, Serrated washer, Shroud

- Optional Thread Length: ≥15mm (Standard: M16-63 Length 15mm, M75 length 20mm M90 - M115 Length 25mm)
- Material for accessories is required

BS 6121 Type of Gland (The suffix for each type of protection)

Single wire armoured	W
Wire braided	X
Aluminium strip armoured	Y
Double steel tape armoured	Z



To Entry

(* in mm)

Part No. (Gland Size)	Entry Thread Size(M)			Thread Length(ℓ)-Min			Cable Dia		Armour Size		Hexagon Dimensions	Weight (g)	Length (L)
	Metric	NPT	Option	Metric	NPT	Option	Inner 'A'	Outer 'B'	Wire	Braid			
OS-E1U/LS 16	M16	1/2"	M20	15	15	15	5 ~ 11.5	9 ~ 15.5	0.9 ~ 1.25	0.05 ~ 0.8	H25 x P27	137	58
OS-E1U/LS 20	M20	1/2"	3/4"	15	15	16	7.5 ~ 15.2	13.2~20.5	0.9 ~ 1.25	0.05 ~ 0.8	H31 x P34	212	66
OS-E1U/LS 25	M25	3/4"	1"	15	16	18	13 ~ 19.6	17 ~ 26	1.25 ~ 1.6	0.05 ~ 0.8	H37 x P40	325	68
OS-E1U/LS 32	M32	1"	1-1/4"	15	18	19	16.5 ~ 26.2	24 ~ 33.5	1.6 ~ 2.0	0.05 ~ 1.2	H47 x P50	570	75
OS-E1U/LS 40	M40	1-1/4"	1-1/2"	15	19	21	23 ~ 32.3	30 ~ 41.5	1.6 ~ 2.0	0.05 ~ 1.2	H56 x P60	876	86
OS-E1U/LS 50	M50	1-1/2"	2"	15	21	24	29 ~ 41.5	38 ~ 50	1.8 ~ 2.5	0.05 ~ 1.2	H70 x P75	1445	93
OS-E1U/LS 63	M63	2"		15	24		39 ~ 50	45 ~ 60	1.8 ~ 2.5	0.05 ~ 1.2	H77 x P82	1740	103
OS-E1U/LS 63X	M63		2-1/2"	15		27	46 ~ 55	55 ~ 66	1.8 ~ 2.5	0.05 ~ 1.2	H82 x P88	1907	104
OS-E1U/LS 75	M75	2-1/2"		20	27		52 ~ 61	58 ~ 72	1.8 ~ 2.5	0.05 ~ 1.2	H92 x P100	3270	110
OS-E1U/LS 75X	M75		3"	20		30	59 ~ 67	66.1 ~ 79	1.8 ~ 2.5	0.05 ~ 1.2	H98 x P106	2912	113
OS-E1U/LS 90	M90	3"	3-1/2"	25	30	32	66 ~ 80	72 ~ 90	1.8 ~ 3.0	0.05 ~ 1.6	H110 x P120	4600	128
OS-E1U/LS 100	M100	3-1/2"	4"	25	32	32	76 ~ 90.5	84 ~ 101.5	1.8 ~ 3.0	0.05 ~ 1.6	H125 x P135	5500	134
OS-E1U/LS 115	M115	4"		25	32		88 ~ 102	100 ~ 116	1.8 ~ 3.0	0.05 ~ 1.6	H135 x P143	5500	141

※ The entry holes need not greater than 0.7mm ※ Up to M75, 1.5 pitch is standard and from M90, 2.0 pitch is standard

OSCU

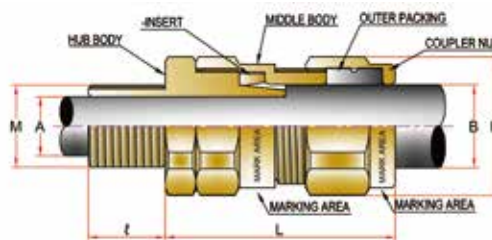

I Application

: Armoured Cable with Single Compression

- For use with any types of armoured cable
- Outdoor & Indoor use
- Weatherproof & Waterproof
- EMC cable gland. (360 ° contact) - EMC tested
- Single compression

Design Specification	BS 6121, IEC 62444, EN/IEC 60529
Ingress Protection	IP 66 (TR No : 299724)
Applicable Cable Specification	All types of Armoured Cable
Gland Material	Nickel Plated Brass(Standard), Brass(Only), Stainless Steel(316L)
Gasket (washer)	Nylon(Standard), PTFE-Teflon(Option)
Packing	Silicone
Accessories (optional)	Lock nut, Sealing washer, Earth tag, Shroud, Serrated washer

I Order Example

Part No.	Thread	Material	Accessories
OSCU	M20	Nickel plated brass	Lock nut, Sealing washer, Earth tag, Serrated washer, Shroud

- Optional Thread Length: ≥ 15 mm (Standard: M16-63 Length 15mm, M75 length 20mm, M90 - M115 Length 25mm)
- Material for accessories is required

(* in mm)

Part No. (Gland Size)	Entry Thread Size(M)			Thread Length(ℓ)-Min			Cable Dia		Armour Size		Hexagon Dimensions	Weight (g)	Length (L)
	Metric	NPT	Option	Metric	NPT	Option	Inner 'A'	Outer 'B'	Wire	Braid			
OSCU 16	M16	1/2"	M20	15	15	15	11.5	9 ~ 15.5	0.9 ~ 1.25	0.05 ~ 0.8	H25 x P27	137	45
OSCU 20	M20	1/2"	3/4"	15	15	16	15.2	13.2 ~ 20.5	0.9 ~ 1.25	0.05 ~ 0.8	H31 x P34	212	48
OSCU 25	M25	3/4"	1"	15	16	18	19.6	17 ~ 26	1.25 ~ 1.6	0.05 ~ 0.8	H37 x P40	325	51
OSCU 32	M32	1"	1-1/4"	15	18	19	26.2	24 ~ 33.5	1.6 ~ 2.0	0.05 ~ 1.2	H47 x P50	570	58
OSCU 40	M40	1-1/4"	1-1/2"	15	19	21	32.3	30 ~ 41.5	1.6 ~ 2.0	0.05 ~ 1.2	H56 x P60	876	77
OSCU 50	M50	1-1/2"	2"	15	21	24	41.5	38 ~ 50	1.8 ~ 2.5	0.05 ~ 1.2	H70 x P75	1445	83
OSCU 63	M63	2"		15	24		50	45 ~ 60	1.8 ~ 2.5	0.05 ~ 1.2	H77 x P82	1740	92
OSCU 63X	M63		2-1/2"	15		27	55	55 ~ 66	1.8 ~ 2.5	0.05 ~ 1.2	H82 x P88	1907	92
OSCU 75	M75	2-1/2"		20	27		61	58 ~ 72	1.8 ~ 2.5	0.05 ~ 1.2	H92 x P100	3270	99
OSCU 75X	M75		3"	20		30	67	66.1 ~ 79	1.8 ~ 2.5	0.05 ~ 1.2	H98 x P106	2912	101
OSCU 90	M90	3"	3-1/2"	25	30	32	80	72 ~ 90	1.8 ~ 3.0	0.05 ~ 1.6	H110 x P120	4600	117
OSCU 100	M100	3-1/2"	4"	25	32	32	90.5	84 ~ 101.5	1.8 ~ 3.0	0.05 ~ 1.6	H125 x P135	5500	122
OSCU 115	M115	4"		25	32		102	100 ~ 116	1.8 ~ 3.0	0.05 ~ 1.6	H135 x P143	5500	127

※ The entry holes need not greater than 0.7mm ※ Up to M75, 1.5 pitch is standard and from M90, 2.0 pitch is standard

OSNU

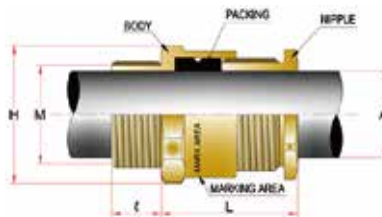

I Application : Non-Armoured Cable

- For use with non-armoured & braided armoured cable
- Weatherproof & Waterproof
- Single compression

Design Specification	BS 6121, IEC 62444, EN 60529
Ingress Protection (Metric)	IP 66 / 68 (request in advance if IP68 required)
(NPT)	NPT tapered hole : IP66 IP68 (apply non-hardening grease) Clearance hole : IP66/68 (using IP Washer)
Applicable Cable Specification	Non-armoured cable, Braided armoured cable
Gland Material	Nickel plated brass (standard), Brass (only), Stainless steel (316L)
Gasket (washer)	Nylon (Standard), PTFE-Teflon (Option)
Packing	Silicone
Accessories (optional)	Lock nut, Sealing washer, Earth tag, Shroud, Serrated washer

I Order Example

Part No.	Thread	Material	Accessories
OSNU 20	M20	Nickel plated brass	Lock nut, Sealing washer, Earth tag, Serrated washer, Shroud

- Optional Thread Length : ≥ 15 mm (Standard : M16 ~ M63 Length 15mm, M75 Length 20mm, M90~M100 Length 25mm)
- Material for accessories is required

(* in mm)

Part No. (Gland Size)	Entry Thread Size(M)			Thread Length(ℓ) - Min			Cable Dia	Hexagon Dimensions	Weight (g)	Length (L)
	Metric	NPT	Option	M/PF	NPT	Option				
OSNU 16	M16	1/2"	M12/M20	15	15	15	3 ~ 7	H24 x P26	79/95	29
OSNU 16X	M16	1/2"	M20	15	15	15	5 ~ 10.3	H24 x P26	79/95	29
OSNU 20	M20	1/2"	3/4"	15	15	16	9 ~ 15.3	H27 x P29	95	31
OSNU 25	M25	3/4"	1"	15	16	18	13 ~ 20	H32 x P34	125	33
OSNU 32	M32	1"	1-1/4"	15	18	19	17 ~ 26.5	H39 x P41.5	195	36
OSNU 40	M40	1-1/4"	1-1/2"	15	19	21	22 ~ 32	H48 x P51	300	39
OSNU 50	M50	1-1/2"	2"	15	21	24	30 ~ 42	H58 x P62	425	41
OSNU 63	M63	2"		15	24		39 ~ 51	H73 x P78	680	44
OSNU 63X	M63		2-1/2"	15		27	46 ~ 55	H73 x P78	575	44
OSNU 75	M75	2-1/2"		20	27		54 ~ 61	H85 x P90	875	48
OSNU 75X	M75		3"	20		30	58 ~ 68	H94 x P99	860	49
OSNU 90	M90	3"	3-1/2"	25	30	32	66 ~ 78	H103 x P109	1690	53
OSNU 100	M100	3-1/2"	4"	25	32	32	77 ~ 89	H112 x P120	2250	59
OSNU 115	M115	4"		25	32		88 ~ 101	H125 x P135	2400	59

※ The entry holes need not greater than 0.7mm ※ Up to M75, 1.5 pitch is standard and from M90, 2.0 pitch is standard

OSNU-F

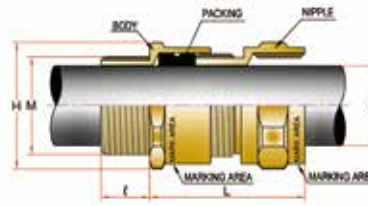

I Application

: Non-Armoured Cable with Male-Female Type

- For use with non-armoured & braided armoured cable
- Male and female threads type
- Weatherproof & Waterproof
- Single compression
- Flexible conduit provided when requested only (refer to OSEP catalogue cut)

Design Specification	BS 6121, IEC 62444, EN 50262
Ingress Protection (Metric) (NPT)	IP 66 / 68 (request in advance if IP68 required) NPT tapered hole : IP66 IP68(apply non-hardensng grease) Clearance hole : IP66/68(using IP Washer)
Applicable Cable Specification	Non-armoured cable, Braided armoured cable
Gland Material	Nickel plated brass(standard), Brass(only), Stainless steel(316L)
Gasket (washer)	Nylon(Standard), PTFE-Teflon(Option)
Packing	Silicone
Accessories (optional)	Lock nut, Sealing washer, Earth tag, Shroud, Serrated washer

I Order Example

Part No.	Thread	Material	Accessories
OSNU-F 20	M20(M)xM20(F)	Nickel plated brass	Lock nut, Sealing washer, Earth tag, Serrated washer, Shroud

- Optional Thread Length: ≥15mm (Standard: M16-63 Length 15mm, M75 length 20mm M90 - M115 Length 25mm)
- Material for accessories is required

(* in mm)

Part No. (Gland Size)	Entry Thread Size(M)			Thread Length(ℓ) - Min			Cable Dia	Hexagon Dimensions	Weight (g)	Length (L)
	Metric	NPT	Option	M/PF	NPT	Option				
OSNU-F 16	M16	1/2"	M12/M20	15	15	15	3 ~ 7	H24 x P26	79/95	42
OSNU-F 16X	M16	1/2"	M20	15	15	15	5 ~ 10.3	H24 x P26	79/95	42
OSNU-F 20	M20	1/2"	3/4"	15	15	16	9 ~ 15.3	H27 x P29	95	46
OSNU-F 25	M25	3/4"	1"	15	16	18	13 ~ 20	H32 x P34	125	48
OSNU-F 32	M32	1"	1-1/4"	15	18	19	17 ~ 26.5	H39 x P41.5	195	52
OSNU-F 40	M40	1-1/4"	1-1/2"	15	19	21	22 ~ 32	H48 x P51	300	55
OSNU-F 50	M50	1-1/2"	2"	15	21	24	30 ~ 42	H58 x P62	425	61
OSNU-F 63	M63	2"		15	24		39 ~ 51	H73 x P78	680	64
OSNU-F 63X	M63		2-1/2"	15		27	46 ~ 55	H73 x P78	575	64
OSNU-F 75	M75	2-1/2"		20	27		54 ~ 61	H85 x P90	875	69
OSNU-F 75X	M75		3"	20		30	58 ~ 68	H94 x P99	860	71
OSNU-F 90	M90	3"	3-1/2"	25	30	32	66 ~ 78	H103 x P109	1690	77
OSNU-F 100	M100	3-1/2"	4"	25	32	32	77 ~ 89	H112 x P120	2250	84
OSNU-F 115	M115	4"		25	32		88 ~ 101	H125 x P135	2400	84

※ The entry holes need not greater than 0.7mm ※ Up to M75, 1.5 pitch is standard and from M90, 2.0 pitch is standard

OSNU-D

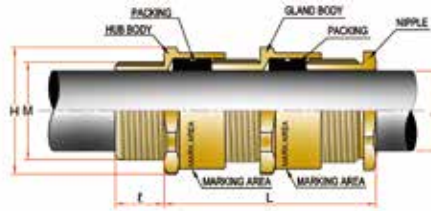

I Application

: Non-Armoured Cable with Double Compression

- For use with non-armoured & braided armoured cable
- Weatherproof & Waterproof
- Double compression

Design Specification	BS 6121, IEC 62444, EN 50262
Ingress Protection (Metric)	IP 66 / 68 (request in advance if IP68 required)
(NPT)	NPT tapered hole : IP66 IP68 (apply non-hardening grease)
	Clearance hole : IP66/68 (using IP Washer)
Applicable Cable Specification	Non-armoured cable, Braided armoured cable
Gland Material	Nickel plated brass (standard), Brass (only), Stainless steel (316L)
Gasket (washer)	Nylon (Standard), PTFE-Teflon (Option)
Packing	Silicone
Accessories (optional)	Lock nut, Sealing washer, Earth tag, Shroud, Serrated washer

I Order Example

Part No.	Thread	Material	Accessories
OSNU-D 20	M20	Nickel plated brass	Lock nut, Sealing washer, Earth tag, Serrated washer, Shroud

- Optional Thread Length: ≥ 15 mm (Standard: M16-63 Length 15mm, M75 length 20mm, M90 - M115 Length 25mm)
- Material for accessories is required

(* in mm)

Part No. (Gland Size)	Entry Thread Size(M)			Thread Length(ℓ) - Min			Cable Dia	Hexagon Dimensions	Length (L)
	Metric	NPT	Option	M/PF	NPT	Option			
OSNU-D 16	M16	1/2"	M12/M20	15	15	15	3 ~ 7	H24 x P26	53
OSNU-D 16X	M16	1/2"	M20	15	15	15	5 ~ 10.3	H24 x P26	53
OSNU-D 20	M20	1/2"	3/4"	15	15	16	9 ~ 15.3	H27 x P29	58
OSNU-D 25	M25	3/4"	1"	15	16	18	13 ~ 20	H32 x P34	61
OSNU-D 32	M32	1"	1-1/4"	15	18	19	17 ~ 26.5	H39 x P41.5	67
OSNU-D 40	M40	1-1/4"	1-1/2"	15	19	21	22 ~ 32	H48 x P51	72
OSNU-D 50	M50	1-1/2"	2"	15	21	24	30 ~ 42	H58 x P62	77
OSNU-D 63	M63	2"		15	24		39 ~ 51	H73 x P78	82
OSNU-D 63X	M63		2-1/2"	15		27	46 ~ 55	H73 x P78	82
OSNU-D 75	M75	2-1/2"		20	27		54 ~ 61	H85 x P90	89
OSNU-D 75X	M75		3"	20		30	58 ~ 68	H94 x P99	92
OSNU-D 90	M90	3"	3-1/2"	25	30	32	66 ~ 78	H103 x P109	98
OSNU-D 100	M100	3-1/2"	4"	25	32	32	77 ~ 89	H112 x P120	108
OSNU-D 115	M115	4"		25	32		88 ~ 101	H125 x P135	116

※ The entry holes need not greater than 0.7mm ※ Up to M75, 1.5 pitch is standard and from M90, 2.0 pitch is standard

OSCG

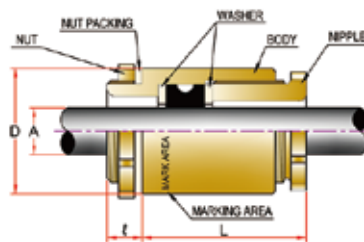

I Application : JIS Standard Type

- For use with Non armoured cable
- Weatherproof & Waterproof
- Single compression

Design Specification	JIS F8801 H - "A" Type Gland
Ingress Protection	IP 66(TR No : 299724)
Applicable Cable Specification	Non-armoured
Gland Material	Chrome plated brass(standard), Nickel plated brass, Brass(only), Stainless steel(316L), Aluminum
Gasket (washer)	NBR
Packing	EPDM, NBR
Accessories (optional)	Lock nut, Sealing washer

I Order Example

Part No.	Thread	Material	Accessories
OSCG - 20A	PF 3/4"	Chrome plated brass	Lock nut, Sealing washer

(* in mm)

Part No. (Gland Size)	Entry Thread Size(M)	Thread Length (\varnothing) - Min	Cable Dia	Packing Inner Dia			D	Length (L)
	PF			A	B	C		
OSCG - 10	3/8"	11	6 ~ 8	7	8		22	33
OSCG - 15	1/2"	11	7.5 ~ 11	9	10	11	28	36
OSCG - 20	3/4"	11	11 ~ 15	12	13	15	34	41
OSCG - 25	1"	11	15 ~ 20	16	18	20	42	47
OSCG - 30	1-1/4"	12	19.5 ~ 26	22	24	26	50	52
OSCG - 35	1-1/2"	12	26 ~ 30	28	30		56	54
OSCG - 40	1-1/2"	12	30 ~ 34	32	34		56	54
OSCG - 45	2"	12	34 ~ 40	36	38	40	70	60
OSCG - 50	2"	12	38 ~ 44	42	44		70	64
OSCG - 55	2-1/2"	12	43 ~ 50	46	48	50	86	73
OSCG - 60	2-1/2"	12	49 ~ 57	52	54	56	86	73
OSCG - 65	3"	14	56 ~ 60	58	60		100	85
OSCG - 70	3"	14	60 ~ 64	62	64		100	85
OSCG - 75	3"	14	64 ~ 71	66	68	70	100	85
OSCG - 80	3-1/2"	15	70 ~ 74	72	74		110	90
OSCG - 85	3-1/2"	15	74 ~ 78	76	78		110	90
OSCG - 90	4"	16	78 ~ 82	80	82		130	94
OSCG - 95	4"	16	82 ~ 86	84	86		130	94
OSCG - 100	4"	16	86 ~ 93	88	93		130	94

※ The entry holes need not greater than 0.7mm

OSEP

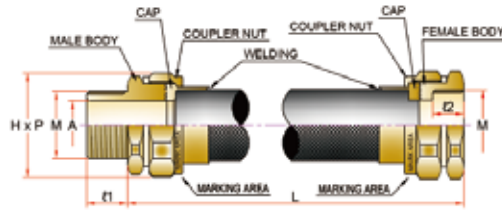

I Application : Flexible Conduit

- Used in narrow space or complicated area which requires flexibility

Ingress Protection	IP 54
Thread Available	Male and Female type, Male and Male type, Female and Female type
Gland Material	Nickel plated brass(Standard), Stainless steel(316L)
Flexible Material	Stainless steel(304, 316L)

I Order Example

Part No.	Thread	Flexible(mm)	Material
OSEP-16	NPT 1/2"(M) x NPT 1/2"(F)	300≤	Gland : Nickel Plated Brass, Flexible : Stainless Steel 304

- Material for accessories is required

(* in mm)

Part No. (Gland Size)	Entry Thread Size(M)	Thread Length(ℓ) - Min		Cable Dia(A) (Max)	Hexagon Dimensions (H x P)	Length (L)
	NPT/PF/PT	Male($\ell 1$)	Female($\ell 2$)			
OSEP - 16	1/2"	15	14	13	H35 x P37	Standard 500mm 700mm 1000mm ≤
OSEP - 22	3/4"	16	15	18	H41 x P43	
OSEP - 28	1"	18	16	22	H50 x P54	
OSEP - 36	1-1/4"	19	17	29	H60 x P63	
OSEP - 42	1-1/2"	21	19	35	H67 x P70	
OSEP - 54	2"	24	22	46	H80 x P83	
OSEP - 70	2-1/2"	27	23	56	H96 x P101	
OSEP - 82	3"	30	26	74	H108 x P113	
OSEP - 104	4"	32	29	88	H145 x P150	

※ The entry holes need not greater than 0.7mm

OSEP-W

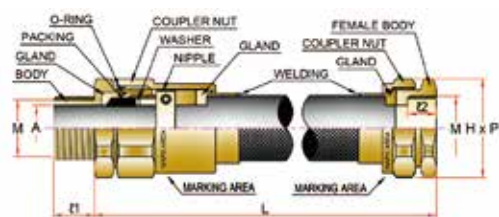

I Application

: One Touch Flexible Conduit

- For use with cable for the factory electrical equipment or machine
- High performance flexibility of seamless tube provides easy
- Workability in the narrow space or complicated area

Thread Available	Male and Female type, Male and Male type
Gland Material	Nickel Plated Brass (Standard), Stainless steel (316L)
Flexible Material	Stainless steel(304, 316L)

I Order Example

Part No.	Thread	Flexible(mm)	Material
OSEP-W-16	NPT 1/2"(M) x NPT 1/2"(F)	300≤	Gland : Nickel Plated Brass, Flexible : Stainless Steel 304

- Material for accessories is required

(* in mm)

Part No. (Gland Size)	Entry Thread Size(M)	Thread Length(ℓ) - Min		Cable Dia(A) (Max)	Hexagon Dimensions (H x P)	Length(L)
	NPT/PF/PT	Male(ℓ_1)	Female(ℓ_2)			Gland
OSEP-W - 16	1/2"	15	14	13	H35 x P37	Standard 500mm 700mm 1000mm ≤
OSEP-W - 22	3/4"	16	15	18	H41 x P43	
OSEP-W - 28	1"	18	16	22	H50 x P54	
OSEP-W - 36	1-1/4"	19	17	29	H60 x P63	
OSEP-W - 42	1-1/2"	21	19	35	H67 x P70	
OSEP-W - 54	2"	24	22	46	H80 x P83	
OSEP-W - 70	2-1/2"	27	23	56	H96 x P101	

※ The entry holes need not greater than 0.7mm

OSXP & OSXP-W



[OSXP]



[OSXP-W]

I Application : Flexible Packing Type

- For use with conduit for electrical equipment or machine
- Outdoor & Indoor use
- Weatherproof & Waterproof

Design Specification	JIS B 0202 thread
Applicable Cable Specification	Non-armoured cable
Gland Material	Nickel Plated Brass(Standard), Brass(only), Stainless Steel(316L)
Packing	EPDM
Accessories (optional)	Nylon(Standard), PTFE-Teflon(Option)

I Order Example

Part No.	Thread	Material	Accessories
OSXP 16	NPT 1/2"	Nickel plated brass	Lock nut, Sealing washer

(* in mm)

Part No. (Gland Size)	Entry Thread Size(M)	Thread Length (ℓ) - Min		Cable Dia	Hexagon Dimensions
		NPT/PF/PT	NPT/PF/PT		
OSXP 16	OSXP - W 16	1/2"	16	6~13	H32 x P34
OSXP 22	OSXP - W 22	3/4"	17	13~18	H38 x P41
OSXP 28	OSXP - W 28	1"	18	18~22	H45 x P48
OSXP 36	OSXP - W 36	1-1/4"	20	22~29	H53 x P57
OSXP 42	OSXP - W 42	1-1/2"	22	29~35	H60 x P64
OSXP 54	OSXP - W 54	2"	24	36~46	H73 x P78
OSXP 70	OSXP - W 70	2-1/2"	26	46~56	H90 x P96

※ The entry holes need not greater than 0.7mm

OSXP-M

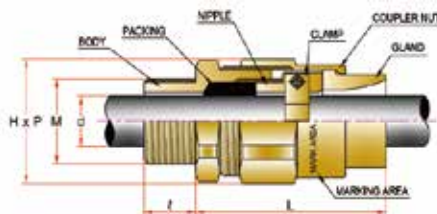

I Application : Cable Packing Type

- For use with cable for electrical equipment or machine
- Outdoor & Indoor use
- Weatherproof & Waterproof

Design Specification	IEC62444
Applicable Cable Specification	Non-armoured cable
Gland Material	Nickel Plated Brass(Standard), Brass(Only), Stainless Steel(316L)
Gasket (washer)	Nylon(Standard), PTFE-Teflon(Option)
Packing	EPDM
Accessories (optional)	Lock nut, Sealing washer

(* in mm)

Part No. (Gland Size)	Entry Thread Size(M)		Thread Length (ℓ) - Min		Cable Dia	Hexagon Dimensions	Length (L)
	Metric	NPT/PF/PT	Metric	NPT/PF/PT			
OSXP-M 16	M20	1/2"	15	16	6~14	H32 x P34	65
OSXP-M 22	M25	3/4"	15	17	14~18	H38 x P41	71
OSXP-M 28	M32	1"	15	18	18~22	H45 x P48	74
OSXP-M 36	M40	1-1/4"	15	20	22~29	H53 x P57	82
OSXP-M 42	M50	1-1/2"	15	22	29~35	H60 x P64	84
OSXP-M 54	M63	2"	15	24	35~46	H73 x P78	90
OSXP-M 70	M75	2-1/2"	20	26	46~56	H90 x P96	100
OSXP-M 82	M90	3"	25	31	56~74	H102 x P109	108
OSXP-M 104	M100	4"	25	33	74~88	H130 x P136	112

※ The entry holes need not greater than 0.7mm

※ Up to M75, 1.5 pitch is standard and from M90, 2.0 pitch standard

OSWD & OSWD-L



[OSWD]



[OSWD-L]

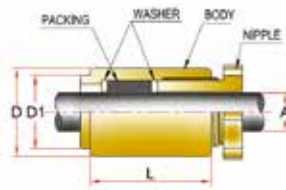

[OSWD]

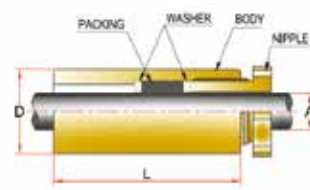

[OSWD-L]

Application : Welding Type

- For use with non-armoured cable
- This cable gland conforms to JIS standard

Design Specification	JIS F8801 H - "C" Type Gland
Applicable Cable Specification	Non-armoured cable
Nipple Material	Chrome plated brass
Body Material	Steel
Packing	EPDM

Order Example

Part No.	Hole / Pipe Size	Length
OSWD-L 10A	PF 3/8"	200

(* in mm)

Part No. (Gland Size)	Pipe Size PF	Cable Dia	Packing Inner Dia			Entry Hole Size		[D]	[D1]	Length[L]		
			A	B	C	OSWD	OSWD-L			OSWD	OSWD-L	
OSWD - 10	OSWD - L - 10	3/8"	6~8	7	8		18	23	22	16	21	50
OSWD - 15	OSWD - L - 15	1/2"	8~11	9	10	11	22	29	28	20	24	
OSWD - 20	OSWD - L - 20	3/4"	11~15	12	13	15	27	35	34	26	27	
OSWD - 25	OSWD - L - 25	1"	15~20	16	18	20	34	43	42	33	31	
OSWD - 30	OSWD - L - 30	1-1/4"	21~26	22	24	26	43	51	50	41	33	
OSWD - 35	OSWD - L - 35	1-1/2"	27~30	28	30		49	57	56	47	35	300
OSWD - 40	OSWD - L - 40	1-1/2"	31~34	32	34		49	57	56	47	35	
OSWD - 45	OSWD - L - 45	2"	35~40	36	38	40	61	71	70	59	40	
OSWD - 50	OSWD - L - 50	2"	41~44	42	44		61	71	70	59	40	

OSPG-R

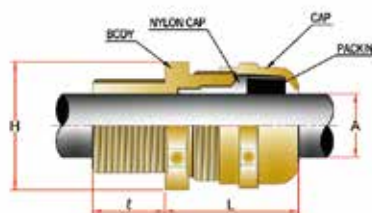

Application : Round Type Cable Gland

- For use with non armoured cable
- Weatherproof & Waterproof
- Single compression

Design Specification	DIN Thread (DIN 40430), ISO Metric Thread
Ingress Protection	IP 66/67(TR No : D0003491)
Applicable Cable Specification	Non-armoured cable
Gland Material	Nickel Plated Brass(Standard), Brass(Only)
Gasket (washer)	NBR, Nylon
Packing	NBR
Accessories (optional)	O-ring, Lock nut, Sealing washer

Order Example

Part No.	Thread	Material	Accessories
OSPG - R 13.5	PG 13.5	Nickel Plated Brass	Lock nut, Sealing washer

OSPG-R PG Thread Type

(* in mm)

Part No.(Gland Size)	Entry Thread Size(M)	Cable Dia[A]	Thread Length[ℓ]	[L]	Hexagon Dimensions
OSPG-R 7	PG 7	2~6.5	5	19	H15 x P16.5
OSPG-R 9	PG 9	4~8	6	22	H18 x P20
OSPG-R 11	PG 11	5~10	6	24	H21 x P23.4
OSPG-R 13.5	PG 13.5	6~12	6.5	25	H23 x P25.5
OSPG-R 16	PG 16	10~14	6.5	26	H26 x P28.8
OSPG-R 21	PG 21	13~17	7	31	H32 x P35.4
OSPG-R 29	PG 29	18~25	8	39	H41 x P45
OSPG-R 36	PG 36	22~32	10	45	H51 x P56
OSPG-R 42	PG 42	30~38	10	47	H57 x P61
OSPG-R 48	PG 48	34~44	10	53	H64 x P69

※ The entry holes need not greater than 0.7mm

OSPG-R Metric Thread Type

(* in mm)

Part No.(Gland Size)	Entry Thread Size(M)	Cable Dia[A]	Thread Length[ℓ]	[L]	Hexagon Dimensions
OSPG-R 12	M12 X 1.5	4~7	6.5	21	H18 x P20
OSPG-R 16	M16 X 1.5	5~10	7	25	H21 x P23.4
OSPG-R 20	M20 X 1.5	9~14	8	27	H26 x P28.8
OSPG-R 25	M25 X 1.5	9~17	9	29	H32 x P35.4
OSPG-R 32	M32 X 1.5	13~21	9	33	H36 x P39.5
OSPG-R 40	M40 X 1.5	19~28	9	40	H45 x P49.5
OSPG-R 50	M50 X 1.5	27~35	10	42	H54 x P59
OSPG-R 63	M63 X 1.5	34~45	15	46	H67 x P73

※ The entry holes need not greater than 0.7mm

OSPGR-P

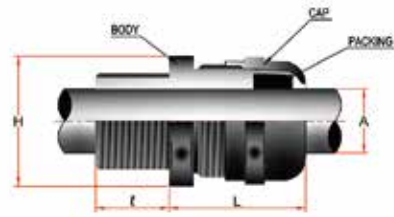

I Application : Round Type Plastic Cable Gland

- For use with non armoured cable
- Weatherproof & Waterproof
- Single compression

Design Specification	DIN Thread (DIN 40430), ISO Metric Thread
Ingress Protection	IP 68
Applicable Cable Specification	Unarmoured Cable
Gland Material	Plastic(Nylon - PA6)
Gasket (O-Ring)	NBR
Packing	NBR
Color	PG : Silver Gray(RAL 7001), Metric : Black(RAL 9005)

I Order Example

Part No.	Thread	Material	Accessories
OSPGR - P 13.5	PG 13.5	Plastic	Lock nut
OSPGR - P M12	M12×1.5	Plastic	
OSPGR - P 16	PG 16	Plastic	

● OSPGR-P PG Thread Type

(* in mm)

Part No.(Gland Size)	Entry Thread Size(M)	Cable Dia[A]	Thread Length[\varnothing]	Entry Hole Size	[H]	[L]
OSPGR-P 7	PG 7	3 ~ 6.5	8	13	15	19
OSPGR-P 9	PG 9	4 ~ 8	8	15.5	19	22
OSPGR-P 11	PG 11	5 ~ 10	8	19	22	24
OSPGR-P 13.5	PG 13.5	6 ~ 12	9	21	24	25
OSPGR-P 16	PG 16	10 ~ 14	10	23	27	26
OSPGR-P 21	PG 21	9 ~ 17	11	29	33	31
OSPGR-P 29	PG 29	18 ~ 25	11	37.5	42	39
OSPGR-P 36	PG 36	22 ~ 32	13	47.5	52	45
OSPGR-P 42	PG 42	32 ~ 38	14	54.5	60	47
OSPGR-P 48	PG 48	37 ~ 44	15	60.5	65	53

● OSPGR-P Metric Thread Type

(* in mm)

Part No.(Gland Size)	Entry Thread Size(M)	Cable Dia[A]	Thread Length[\varnothing]	Entry Hole Size	[H]	[L]
OSPGR-P 12	M12 X 1.5	3 ~ 6.5	8	13	15	21
OSPGR-P 16	M16 X 1.5	4 ~ 8	8	17	19	25
OSPGR-P 20	M20 X 1.5	6 ~ 12	10	21	24	27
OSPGR-P 25	M25 X 1.5	9 ~ 17	11	26	33	29
OSPGR-P 32	M32 X 1.5	18 ~ 25	11	33	42	33
OSPGR-P 40	M40 X 1.5	22 ~ 32	13	41	52	40
OSPGR-P 50	M50 X 1.5	32 ~ 38	16	51	60	42
OSPGR-P 63	M63 X 1.5	37 ~ 44	15	64	65	46

OSPGM & OSPGM-Z



[OSPGM / OSPGM-Z]

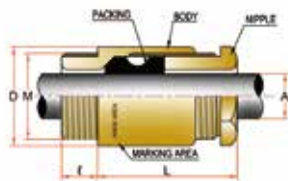

[OSPGM]

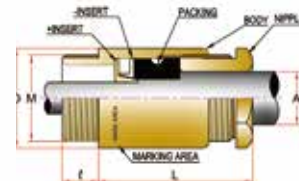

[OSPGM-Z]

Application : DIN 89280 Type

- For use with military vessels
- Hexagon nipple and lock nut

Design Specification	DIN 89280 Type Gland
Ingress Protection	IP 66/67(TR No : D0003491)
Applicable Cable Specification	OSPGM : Unarmoured Cable OSPGM-Z : Braided Armoured Cable
Gland Material	Chrome plated brass(standard), Nickel plated brass, Brass(only), Stainless steel(316L)
Gasket (washer)	NBR, EPDM
Packing	EPDM
Accessories (optional)	Lock nut, Sealing washer, Earth tag, Serrated washer

Order Example

Part No.	Thread	Material	Accessories
OSPGM 18A	M18 X 1.5	Chrome plated brass	Lock nut, Sealing washer

(* in mm)

Part No. (Gland Size)		Entry Thread Size[M]	Cable Dia[A]	Packing Inner Dia	Thread Length[ℓ]	Dimension[D]	OSPGM [L]	OSPGM-Z [L]	
OSPGM 18	OSPGM-Z 18	M18 X 1.5	7 ~ 10	A	8	10	D22	32	
				B	10				40
OSPGM 24	OSPGM-Z 24	M24 x 1.5	7 ~ 17	A	8	11	D28	36	
				B	10				43
				C	12				
				D	14				
				E	16				
				F	17				
OSPGM 30	OSPGM-Z 30	M30 X 2.0	16 ~ 20	A	18	12	D35	40	
				B	20				48
OSPGM 36	OSPGM-Z 36	M36 X 2.0	20 ~ 26	A	22	13	D41	44	
				B	24				51
				C	26				
OSPGM 45	OSPGM-Z 45	M45 X 2.0	26 ~ 32	A	28	14	D51	47	
				B	30				55
				C	32				
OSPGM 56	OSPGM-Z 56	M56 X 2.0	32 ~ 41	A	35	15	D62	52	
				B	38				59
				C	41				
OSPGM 72	OSPGM-Z 72	M72 X 2.0	41 ~ 56	A	44	16	D78	56	
				B	48				64
				C	52				
				D	56				

OSAJ

Certificates	
Classifications	

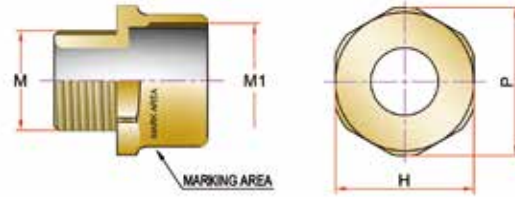

I Application : Adaptor

- Provides a means of thread conversion

Design Specification	BS 6121, IEC 62444, EN 50262
Compliance Standard	IEC/EN 60079-0, 1, 7, 31
ATEX Certification	DNV 22 ATEX 52701X, Presafe 16 ATEX 7985X
IECEX Certification	IECEX DNV 22.0069X, IECEX PRE 15.0019X
KCs Certification	15-AV2B0-0140~2, 19-AV2B0-0504~6X
TR CU Certification	RU C- KR.AA87.B.01105
PESO Certification	P465223
CCC Certification	2020332313000816
INMETRO Certification	DNV 21.0161X
NR TL(UL, CSA) Certification	LR1634-2
Code of Protection	II2G Ex db IIC Gb, Ex eb IIC Gb, II2D Ex tb IIIC Db 1 AEx db IIC Gb, AEx eb IIC Gb, 21 AEx tb IIIC Db
Operating Temperature	-60 ° C ~ 110 ° C
Regulation	Zone 1,2 & 21,22, Gas Group IIA, IIB, IIC, Dust Group IIIA, IIIB, IIIC
Ingress Protection (Metric) (NPT)	IP 66 / 68 (request in advance if IP68 required) NPT tapered hole : IP66 IP68(apply non-hardensng grease) Clearance hole : IP66/68(using IP Washer)
Applicable Cable Specification	Non-armoured cable, Braided amoured cable
Gland Material	Nickel plated brass(standard), Brass(only), Stainless steel(316L)
Gasket (washer)	Nylon(Standard), PTFE-Teflon(Option)
Accessories (optional)	Lock nut, Sealing washer

• The standard applied to KCs is Korean industrial standard created by translating IEC international standards without changing the technical content and standard format.

I Order Example

Part No.	Thread	Material	Accessories
OSAJ 01	M16 X M20	Nickel plated brass	Lock nut, Sealing washer

• Part No Example : OSAJ 0809(OSAJ, NPT 3" x NPT 3-1/2") => Please refer to the below table

• Other than IECEX, ATEX and KCs marking, the marking requirement must be informed when ordered.

OSAJ		Female thread size(M1)																				
		METRIC									NPT/PF											
		M16	M20	M25	M32	M40	M50	M63	M75	M90	M100	3/8"	1/2"	3/4"	1"	1-1/4"	1-1/2"	2"	2-1/2"	3"	3-1/2"	4"
Metric	M16	00	01	02	03							000	001	002	003							
	M20		11	12	13	14							101	102	103	104						
	M25			22	23	24	25							202	203	204	205					
	M32				33	34	35	36							303	304	305	306				
	M40					44	45	46	47							404	405	406	407			
	M50						55	56	57	58							505	506	507	508		
	M63							66	67	68	69							606	607	608	609	
	M75								77	78	79								707	708	709	710
	M90									88	89									808	809	810
	M100										99										909	910
NPT/PF	3/8"	000	001	002	003							0000	0001	0002	0003							010
	1/2"		011	012	013	014							0101	0102	0103	0104						
	3/4"			022	023	024	025							0202	0203	0204	0205					
	1"				033	034	035	036							0303	0304	0305	0306				
	1-1/4"					044	045	046	047							0404	0405	0406	0407			
	1-1/2"						055	056	057	058							0505	0506	0507	0508		
	2"							066	067	068	069							0606	0607	0608	0609	
	2-1/2"								077	078	079								0707	0708	0709	0710
	3"									088	089									0808	0809	0810
	3-1/2"										099										0909	0910
4"																					1010	

OSRA



Certificates	
Classifications	

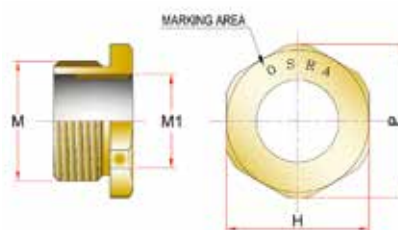

I Application : Reducer

- Provides a means of thread conversion

Design Specification	BS 6121, IEC 62444, EN 50262
Compliance Standard	IEC/EN 60079-0, 1, 7, 31
ATEX Certification	DNV 22 ATEX 52701X, Presafe 16 ATEX 7985X
IECEX Certification	IECEX DNV 22.0069X, IECEX PRE 15.0019X
KCs Certification	15-AV2BO-0140~2, 19-AV2BO-0504~6X
TR CU Certification	RU C-KR.AA87.B.01105
PESO Certification	P465223
CCC Certification	2020332313000816
INMETRO Certification	DNV 21.0161X
NR TL(UL, CSA) Certification	LR1634-2
Code of Protection	II2G Ex db IIC Gb, Ex eb IIC Gb, II2D Ex tb IIIC Db 1 AEx db IIC Gb, AEx eb IIC Gb, 21 AEx tb IIIC Db
Operating Temperature	-60 ° C ~ 110 ° C
Regulation	Zone 1,2 & 21,22, Gas Group IIA, IIB, IIC, Dust Group IIIA, IIIB, IIIC
Ingress Protection (Metric) (NPT)	IP 66 / 68 (request in advance if IP68 required) NPT tapered hole : IP66 IP68(apply non-hardensng grease) Clearance hole : IP66/68(using IP Washer)
Applicable Cable Specification	Non-armoured cable, Braided amoured cable
Gland Material	Nickel plated brass(standard), Brass(only), Stainless steel(316L)
Gasket (washer)	Nylon(Standard), PTFE-Teflon(Option)
Accessories (optional)	Lock nut, Sealing washer

• The standard applied to KCS is Korean industrial standard created by translating IEC international standards without changing the technical content and standard format.

I Order Example

Part No.	Thread	Material	Accessories
OSRA 21	M25 X M20	Nickel plated brass	Lock nut, Sealing washer

• Part No Example : OSRA20(OSRA, M25 x M16) => Please refer to the below table

• Other than IECEX, ATEX and KCs marking, the marking requirement must be informed when ordered.

OSRA		Female thread size(M1)																					
		METRIC										NPT/PF											
		M16	M20	M25	M32	M40	M50	M63	M75	M90	M100	3/8"	1/2"	3/4"	1"	1-1/4"	1-1/2"	2"	2-1/2"	3"	3-1/2"	4"	
Metric	M16																						
	M20	10												100									
	M25	20	21											200	201								
	M32	30	31	32										300	301	302							
	M40	40	41	42	43									400	401	402	403						
	M50	50	51	52	53	54								500	501	502	503	504					
	M63	60	61	62	63	64	65							600	601	602	603	604	605				
	M75		71	72	73	74	75	76							701	702	703	704	705	706			
	M90			82	83	84	85	86	87							802	803	804	805	806	807		
	M100				93	94	95	96	97	98							903	904	905	906	907	908	
NPT/PF	3/8"																						
	1/2"	010												0100									
	3/4"	020	021											0200	0201								
	1"	030	031	032										0300	0301	0302							
	1-1/4"	040	041	042	043									0400	0401	0402	0403						
	1-1/2"	050	051	052	053	054								0500	0501	0502	0503	0504					
	2"	060	061	062	063	064	065							0600	0601	0602	0603	0604	0605				
	2-1/2"		071	072	073	074	075	076							0701	0702	0703	0704	0705	0706			
	3"			082	083	084	085	086	087							0802	0803	0804	0805	0806	0807		
	3-1/2"				093	094	095	096	097	098							0903	0904	0905	0906	0907	0908	
4"					104	105	106	107	108	109							1004	1005	1006	1007	1008	1009	

OSSP

Certificates	
Classifications	



[OSSP(H)]



[OSSP(R)]



[OSSP(T)]

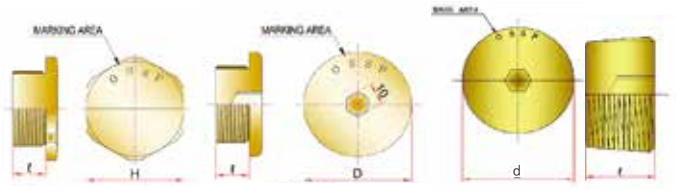

[OSSP(H)]

[OSSP(R)]

[OSSP(T)]

I Application : Stopping Plug

- Provides a means of blanking for unused or spare entries
- When the plug is used for Ex d with NPT thread, OSSP(T) type must be used due to non-shoulder requirement in accordance with IEC standard.

Design Specification	BS 6121, IEC 62444, EN 50262
Compliance Standard	IEC/EN 60079-0, 1, 7, 31
ATEX Certification	DNV 22 ATEX 52701X, Presafe 16 ATEX 7985X
IECEx Certification	IECEx DNV 22.0069X, IECEx PRE 15.0019X
KCs Certification	15-AV2B0-0144~6, 19-AV2B0-0498~0500X
TR CU Certification	RU C- KR.AA87.B.00251/19
PESO Certification	P465223
CCC Certification	2020332313000816
INMETRO Certification	DNV 21.0141X
NR TL(UL, CSA) Certification	LR1634-2
Code of Protection	II2G Ex db IIC Gb, Ex eb IIC Gb, II2D Ex tb IIIC Db 1 AEx db IIC Gb, AEx eb IIC Gb, 21 AEx tb IIIC Db
Operating Temperature	-60 ° C ~ 110 ° C
Regulation	Zone 1,2 & 21,22, Gas Group IIA, IIB, IIC, Dust Group IIIA, IIIB, IIIC
Ingress Protection (Metric) (NPT)	IP 66 / 68 (request in advance if IP68 required) NPT tapered hole : IP66 IP68(apply non-hardensng grease) Clearance hole : IP66/68(using IP Washer)
Gland Material	Nickel plated brass(standard), Brass(only), Stainless steel(316L)
Gasket (washer)	Nylon(Standard), PTFE-Teflon(Option)
Accessories (optional)	Lock nut, Sealing washer

• The standard applied to KCs is Korean industrial standard created by translating IEC international standards without changing the technical content and standard format.

I Order Example

Part No.	Thread	Material	Accessories
OSSP - H16	M16	Nickel plated brass	Lock nut, Sealing washer

- Optional Thread Length : ≥15mm (Standard : M16~M75 Lenth 15mm, M90~M100 Length 25mm)
- For OSSP-T, only NPT thread is available
- Other than IECEx, ATEX and KCs marking, the marking requirement must be informed when ordered.

(* in mm)

Part No. (Gland Size)	Entry Thread		Thread Length[ℓ]		H/R Dimensions		Weight(g)		
	Metric	NPT/PF	Metric/PF	NPT	Metric(H/D)	NPT/PF(H/D)	OSSP-H	OSSP-R	OSSP-T
OSSP-H / R / T	M16		15		21/22		50	35	
OSSP-H / R / T	M20	1/2"	15	15	27/27	27/27	75	55	30
OSSP-H / R / T	M25	3/4"	15	16	31/32	31/32	100	90	55
OSSP-H / R / T	M32	1"	15	18	38/40	38/40	120	155	100
OSSP-H / R / T	M40	1-1/4"	15	19	46/50	46/50	195	250	160
OSSP-H / R / T	M50	1-1/2"	15	21	57/57	57/55	310	410	265
OSSP-H / R / T	M63	2"	15	24	70/70	70/70	475	655	430
OSSP-H / R / T	M75	2-1/2"	15	27	82/82	82/82	730	890	650
OSSP-H / R / T	M90	3"	20	30	98/98	98/98	950	1150	920
OSSP-H / R / T	M100	3-1/2"	20	32	112/112	112/112	1285	1550	1210
		4"		32		125/123	1285	1550	

※ Up to M75, 1.5 pitch is standard and from M90, 2.0 pitch is standard

※ In accordance with IEC 60079-1 C.2.3.3 NPT blanking element shall have no shoulder. Therefore, only OSSP (T) is available for Ex db with NPT thread

OSAE



Certificates	
Classifications	

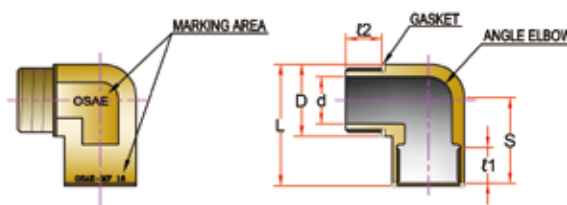

Application : Elbow(90°)

- Provides a means of bending due to crawlspace

Design Specification	BS 6121, IEC 62444, EN 50262
Compliance Standard	IEC/EN 60079-0, 1, 7, 31
ATEX Certification	Presafe 16 ATEX 7984U, DNV 22 ATEX 52695U
IECEX Certification	IECEX KOS 09.0004X, IECEx PRE 15.0022U, IECEx DNV 22.0070U
KCs Certification	15-AV2BO-0150~2
TR CU Certification	RU C-KR.AA87.B.00251/19
PESO Certification	P465223
CCC Certification	2020332313000846
INMETRO Certification	DNV 21.0142U
NR TL(UL, CSA) Certification	LR1634-2
Code of Protection	II2G Ex db IIC Gb, Ex eb IIC Gb, II2D Ex tb IIIC Db 1 AEx db IIC Gb, AEx eb IIC Gb, 21 AEx tb IIIC Db
Operating Temperature	-60 ° C ~ 110 ° C
Regulation	Zone 1,2 & 21,22, Gas Group IIA, IIB, IIC, Dust Group IIIA, IIIB, IIIC
Ingress Protection (Metric) (NPT)	IP 66 / 68 (request in advance if IP68 required) NPT tapered hole : IP66 IP68(apply non-hardensng grease) Clearance hole : IP66/68(using IP Washer)
Gland Material	Nickel plated brass(standard), Brass(only), Stainless steel(316L)
Gasket (washer)	Nylon(Standard), PTFE-Teflon(Optional)
Accessories (optional)	Lock nut, Sealing washer

* The standard applied to KCS is Korean industrial standard created by translating IEC international standards without changing the technical content and standard format.

Order Example

Part No.	Thread	Material	Accessories
OSAE - 16	M16 X M16	Nickel plated brass	Lock nut, Sealing washer

- Only Metric and NPT Thread
- Other than IECEX, ATEX and KCs marking, the marking requirement must be informed when ordered.

(* in mm)

Part No. (Gland Size)	Entry Thread Size[M]				D	d	S	ℓ1	ℓ2	Length[L]
	Metric		NPT							
	Male	Female	Male	Female						
OSAE 16	M16	M16	1/2"	1/2"	27	11	29	17	15	43
OSAE 20	M20	M16	1/2"	1/2"	27	14	29	17	15	43
		M20								
OSAE 25	M25	M16	3/4"	1/2"	32	19.5	34	18	15	50
		M20		3/4"						
		M25								
OSAE 32	M32	M32	1"	1"	39	26	43	18	15	62
OSAE 40	M40	M40	1-1/4"	1-1/4"	48	33	49	20	19	73
OSAE 50	M50	M50	1-1/2"	1-1/2"	58	40	56	23	20	85

OSAJ(I)



Certificates	CE, RoHS, ATEX, EAC, KCs, IECEx
Classifications	II, III, IIIA, IIIB, IIIC

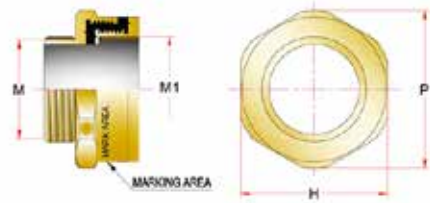

I Application : Insulated Adaptor

- Provides insulation for short circuit for sensitive equipment

Design Specification	BS 6121, IEC 62444, EN/IEC 60529
Compliance Standard	IEC/EN 60079-0, 1, 7, 31
ATEX Certification	Presafe 16 ATEX 9168X
IECEX Certification	IECEX PRE 16.0093X
TR CU Certification	RU C- KR.AA87.B.01105
PESO Certification	P465223
INMETRO Certification	DNV 21.0145X
Code of Protection	II2G Ex db IIC Gb, Ex eb IIC Gb, II2D Ex tb IIIC Db
Operating Temperature	-20 °C ~ 110 °C
Regulation	Zone 1,2 & 21,22, Gas Group IIA, IIB, IIC, Dust Group IIIA, IIIB, IIIC
Ingress Protection	IP 66 / 67
Gland Material	Nickel plated brass(standard), Brass(Only), Stainless steel(316L)
Gasket (washer)	Nylon(Standard), PTFE-Teflon(Option)
Accessories (optional)	Lock nut, Sealing washer

I Order Example

Part No.	Thread	Material	Accessories
OSAJ(I) 50	M50 x M50	Nickel plated brass	Lock nut, Sealing washer
OSAJ(I) 50	M50 x M50	Stainless steel(316L)	

- Other than IECEX, ATEX and KCs marking, the marking requirement must be informed when ordered.

Part No. (Gland Size)	Entry Thread Size		Hexagon Dimension
	M(Male)	M1(Female)	
OSAJ(I) 20	M20	M20	H39 X P41.5
OSAJ(I) 25	M25	M25	H45 X P49
OSAJ(I) 32	M32	M32	H55 X P59
OSAJ(I) 40	M40	M40	H68 X P73
OSAJ(I) 50	M50	M50	H70 X P75
OSAJ(I) 63	M63	M63	H85 X P90
OSAJ(I) 75	M75	M75	H98 X P106
OSAJ(I) 90	M90	M90	H112 X P120
OSAJ(I) 100	M100	M100	H125 X P135
OSAJ(I) 115	M115	M115	H135 X P143

*Thread conversion between male and female is not allowed

OSBD



Certificate Logos	CE, RoHS, ATEX, EAC, KCs, IECEx
Classification Logos	II, III, IIIA, IIIB, IIIC

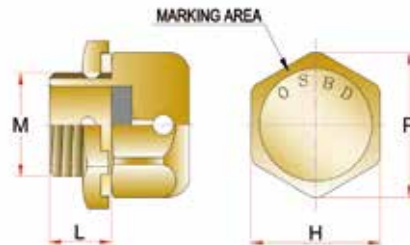

I Application : Breather Drains

- Provides draining water from an enclosure and breathing air out for ventilation

Design Specification	BS 6121, IEC 62444, EN/IEC 60529
Compliance Standard	IEC/EN 60079-0, 7, 31
ATEX Certification	Presafe 20 ATEX 13763X
IECEX Certification	IECEX PRE 20.0110X
KCs Certification	17-KA2BO-0309~0310U
TR CU Certification	RU C- KR.AA87.B.01105
PESO Certification	P465223
INMETRO Certification	DNV 21.0144X
Code of Protection	II2G Ex eb IIC Gb, II2D Ex tb IIIC Db
Operating Temperature	-60 °C ~ 110 °C
Regulation	Zone 1,2 & 21,22, Gas Group IIA, IIB, IIC, Dust Group IIIA, IIIB, IIIC
Ingress Protection	IP 66
Gland Material	Nickel plated brass(standard), Brass(Only), Stainless steel(316L)
Gasket (washer)	PTFE(Teflon)
Filter	Copper compressed metallic sinter
Accessories (optional)	Lock nut, Sealing washer

I Order Example

Part No.	Thread	Material	Accessories
OSBD	M20 X 1.5	Nickel plated brass	Lock nut, Sealing washer
OSBD	NPT 3/4"	Stainless steel(316L)	

- Other than IECEX, ATEX and KCs marking, the marking requirement must be informed when ordered.

Part No.	Entry Thread Size(M)		Thread Length(L)		Hexagon Dimension
	Metric	NPT	Metric	NPT	
OSBD	M 20	NPT 1/2"	12	16	H25 X P28 H32 X P34
	M 25	NPT 3/4"			

OSET

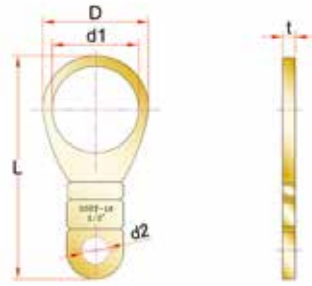

Application : Earth Tag

- Provides an earth bonding
- Nickel plated brass(standard), Brass(only), Stainless steel(316L), Aluminum

Order Example

Part No.	Material
OSET 16	Nickel plated brass

(* in mm)

Part No.	Entry Thread Size		D	d1	d2	t	L
	Metric	NPT/PF/PT					
OSET 16	M16	3/8"	24	17.5	7	1.5	59
OSET 20	M20	1/2"	30	21.5	7	1.5	72
OSET 25	M25	3/4"	35	27	7	1.5	82.5
OSET 32	M32	1"	44	33.5	13.5	1.5	99
OSET 40	M40	1-1/4"	54	42.5	13.5	1.5	112
OSET 50	M50	1-1/2"	67	50.5	13.5	1.5	125
OSET 63	M63	2"	81	63.5	13.5	1.5	155
OSET 75	M75	2-1/2"	97	76	14	1.5	163
OSET 90	M90	3"	110	91	14	1.5	178
OSET 100	M100	3-1/2"	120	103	14	1.5	195
OSET 115	M115	4"	130	116	14	1.5	208

OSEZ



[Compound with compound gun]



[Nozzle]



[Compound]

Application : Liquid Compound Resin

- EZsafe is easy and safe for installation
- Requires compound gun to install
- Material: Epoxy
- Volume : 50ml
- OSCG provided nozzle must be used
- Waste compound by pressing the gun full 2 times before use for equivalent mixing

Order Example

Part No.	Material
OSEZ	Liquid Epoxy

Recommended Compound per gland Size		Ambient Temp. / Curing Time	Heat rises from 30°C to 60°C when curing
M16	1/10	10°C / 10 min	
M20	1/8		
M25	1/6		
M32	1/2	20°C / 7 min	
M40	1		
M50	2		
M63	2		
M63X	2	30°C / 6 min	
M75	2.5		
M75X	2.5		
M90	3	40°C / 3 min	
M100	3		
M115	3.5		

* The recommended compound per gland size is up to the number and size of cable cores

OSSH

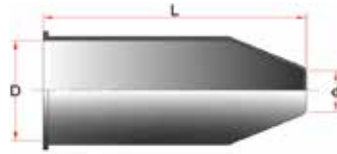

Application : Shroud

- Provide means of protection for additional IP and corrosion
- Material : PCP(CR70) or PVC
- Thermal endurance tested (-67°C ~ 130°C)

Item data sheet

(* in mm)

Part No.	A			B			D		
	D	d	L	D	d	L	D	d	L
OSSH- 16	28	6	93	24	4	52	25	4	93
OSSH- 20	35	10	98	28	7	55			
OSSH- 25	40	14	102	32	12	59			
OSSH- 32	50	18	115	40	15	65			
OSSH- 40	60	24	124	50	21	71			
OSSH- 50	74	30	132	60	28	79			
OSSH- 63	83	41	150	78	30	111			
OSSH- 63X	89	38	152						
OSSH- 75	101	54	170						
OSSH- 75X	107	53	171						
OSSH- 90	121	72	175						
OSSH- 100	131	86	190						
OSSH- 115	141	96	220						

Order Example

Part No.	Material
OSSH-A-16	PVC

SELECTION CHART

GLAND SIZE	OSCU, OS-E1UF, OS-E1UF/LS, E1U, E1U/LS, OS-EXBF, OS-EXBF/LS, OS-EXBF-A, OS-EXBF-F	OSNJ-A2F, OSNJ	OS-A2F-U, OSNU	OS-A2F-UF, OS-A2F-UD, OSNU-F, OSNU-D
16	OSSH-A-16	OSSH-B-16	OSSH-B-16	OSSH-D-16
16X			OSSH-B-16	OSSH-D-16
20	OSSH-A-20	OSSH-B-20	OSSH-B-20	OSSH-A-16
25	OSSH-A-25	OSSH-B-25	OSSH-B-25	OSSH-A-20
32	OSSH-A-32	OSSH-B-32	OSSH-B-32	OSSH-A-25
40	OSSH-A-40	OSSH-B-40	OSSH-B-40	OSSH-A-32
50	OSSH-A-50	OSSH-B-50	OSSH-B-50	OSSH-A-40
63	OSSH-A 63	OSSH-B-63	OSSH-B-63	OSSH-A-50
63X	OSSH-A 63X		OSSH-B-63	OSSH-A-50
75	OSSH-A 75	OSSH-A-63	OSSH-A-63	OSSH-A-63
75X	OSSH-A 75X		OSSH-A-75	OSSH-A-75
90	OSSH-A-90	OSSH-A-75	OSSH-A-75X	OSSH-A-75X
100	OSSH-A-100	OSSH-A-90	OSSH-A-90	OSSH-A-90
115	OSSH-A-115		OSSH-A-100	OSSH-A-100

OSTW

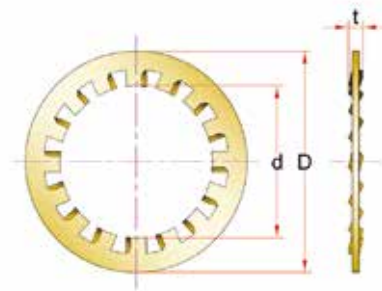

Application : Serrated Washer / Teeth Washer

- Provides means of prevention for loosening due to vibration
- Material : Stainless steel(316L)

Order Example

Part No.	Material
OSTW 16	Stainless steel

(* in mm)

Part No.	Entry Thread Size		D	d	t
	Metric	NPT/PF/PT			
OSTW 16	M16	3/8"	26	17.5	2.0
OSTW 20	M20	1/2"	32	21.5	3.0
OSTW 25	M25	3/4"	38	27	3.0
OSTW 32	M32	1"	46	33.4	3.5
OSTW 40	M40	1-1/4"	57	42.4	3.5
OSTW 50	M50	1-1/2"	72	50.5	3.5
OSTW 63	M63	2"	87	64	4.0
OSTW 75	M75	2-1/2"	98	76	4.0
OSTW 90	M90	3"	113	91	4.0
OSTW 100	M100	3-1/2"	124	103	4.0
OSTW 115	M115	4"	140	116	4.0

OSLS

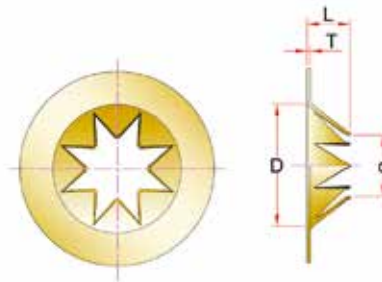

Application : Lead Sheath Washer

- For use of lead sheathed cable
- Material : Nickel plated brass

Order Example

Part No.	Material	Use
OSLS 16	Nickel plated brass	OS-A2F-U 16

(* in mm)

Part No.	D	d	L	T
OSLS-16	10	6	3.5	0.2
OSLS-20	14	6	4.5	0.35
OSLS-25	18	11	7	0.35
OSLS-32	25	16	10.5	0.35
OSLS-40	31	21	12	0.5
OSLS-50	40	27	13	0.5
OSLS-63	53	38	16	0.5
OSLS-75	61	47	18	0.5
OSLS-90	70	57	18	0.6
OSLS-100	83	64	19	0.7
OSLS-115	102	78	19	0.7

OSLN



[OSLN]



[OSLN-T]

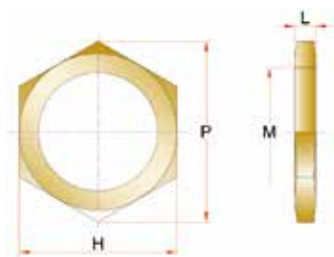

Application : Lock Nut

- Secure a cable gland in position of the equipment
- Material : Nickel plated brass(Standard), Brass(only), Stainless steel(316L)

Order Example

Model	Thread size	Material
OSLN	M16	Nickel plated brass

Metric & NPT/PF Type

(* in mm)

Type	Metric Thread			Type	NPT & PF Thread		
Part No.	H	P	L	Part No.	H	P	L
OSLN M16	22	25	4	OSLN 1/2"	27	31	4
OSLN M20	27	31	4	OSLN 3/4"	32	36	4
OSLN M25	32	36.5	4	OSLN 1"	39	45	5
OSLN M32	39	44.5	5	OSLN 1-1/4"	48	55.5	5
OSLN M40	48	55	5	OSLN 1-1/2"	60	67	6
OSLN M50	60	69	5	OSLN 2"	73	87	6
OSLN M63	73	84	6	OSLN 2-1/2"	85	98	6
OSLN M75	85	98	6	OSLN 3"	102	119	10
OSLN M90	102	117	10	OSLN 3-1/2"	112	126	12
OSLN M100	112	128	12	OSLN 4"	125	144	12
OSLN M115	125	144	12				

PG Type

(* in mm)

Type	PG Thread			Type	Metric Thread		
Part No.	H	P	L	Part No.	H	P	L
OSLN PG7	15	16.5	3	OSLN PG M12	14	15	3
OSLN PG9	18	20.0	3	OSLN PG M16	18	20	3
OSLN PG11	21	23.4	3	OSLN PG M20	22	25	3
OSLN PG13.5	23	25.5	3	OSLN PG M25	27	30	4
OSLN PG16	26	28.8	3	OSLN PG M32	36	40	4
OSLN PG21	32	35.4	4	OSLN PG M40	45	50	5
OSLN PG29	41	45.0	4	OSLN PG M50	54	59	5
OSLN PG36	51	56.0	5	OSLN PG M63	67	73	6
OSLN PG42	60	65.0	5				
OSLN PG48	66	73.0	6				

Note.
For OSPG-R metric thread type.

OSSR

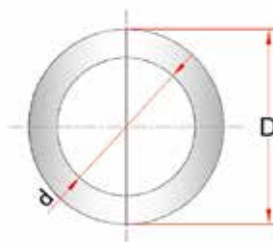
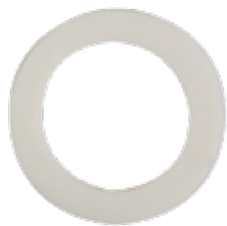

I Application : Sealing Washer

- Sealing for IP Grade
- Material : Nylon, PTFE(Teflon)
- Not selling separately with glands

I Order Example

Model	Type	Size
OSSR	OS-E1UF	M16
OSSR	OS-A2F-U	NPT 1/2"

● Armour Type & Non Armour Type (Nylon & PTFE)

(* in mm)

TYPE Part No.	Armour Type			Non Armour Type		
	D	d	t	D	d	t
OSSR M16	26	16	2	24	16	2
OSSR M20	30	20	2	27	20	2
OSSR M25	35	25	2	32	25	2
OSSR M32	44	32	2	40	32	2
OSSR M40	53	40	2	48	40	2
OSSR M50	66	50	2	58	50	2
OSSR M63	81	64	2	73	64	2
OSSR M75	97	75	2	85	75	2
OSSR M90	110	90	2	100	90	2
OSSR M100	119	100	2	112	100	2
OSSR M115	134	115	2	116	115	2

● NPT & PF Thread (only PTFE)

(* in mm)

Type Part No.	NPT Thread			PF Thread		
	D	d	t	D	d	t
OSSR 1/2"	30	22	2	30	22	2
OSSR 3/4"	35	27	2	35	27	2
OSSR 1"	44	34	2	44	34	2
OSSR 1-1/4"	54	43	2	50	42	2
OSSR 1-1/2"	67	49	2	58	48	2
OSSR 2"	81	61	2	70	60	2
OSSR 2-1/2"	86	73	2	86	75.5	2
OSSR 3"	110	90	2	104	88	2
OSSR 3-1/2"	120	102	2	114	100	2
OSSR 4"	125	114	2	125	113.5	2

Spanner



Application

- Used for installation of Cable Glands
- Applicable Products
 - OS-E1UF
 - OS-A2F-U BODY
 - OS-A2F-U NIPPLE
 - LOCK NUT

Spanner Size	Cable Gland Thread Size	Lock Nut Size	Spanner Length			Lock Nut
			OS-E1UF	OS-A2F-U Bpdy	OS-A2F-U Nipple	
SPANNER 16/20	16 / 20	M16 / M20	265	260	253	240
SPANNER 25/32	25 / 32	M25 / M32	290	277	270	250
SPANNER 40	40	M40	305	298	293	300
SPANNER 50	50	M50	332	308	303	305
SPANNER 63	63	M63	340	335	332	325
SPANNER 63X	63	-	345	335	332	-
SPANNER 75	75	M75	355	347	341	335
SPANNER 75X	75	-	357	356	349	-
SPANNER 90	90	M90	467	375	358	345
SPANNER 100	100	M100	493	470	472	450
SPANNER 115	115	M115	505	497	492	460

Materials

Structural Steel S45C (Nickel Plated)

Regulation

According to KS standard

Spanner Ordering (Size)

- e.g. SPANNER-16/20 (for Lock Nut)
 SPANNER-50 (for Lock Nut)
 SPANNER-16/20 (for OS-E1UF)
 SPANNER-50 (for OS-A2F-U)

• Note

Used for installing OS-E1UF/OS-E1U/OSNJ-CW
 Lock Nut M16-M20 / M25-M32 can be used for installing 2 sized of Cable Gland

Note



OSCG Co.,Ltd.

CABLE GLAND / JUNCTION BOX
hazardous & industrial area



JUNCTION BOX

Hazardous > Industrial > NEC Standard (in process)



Junction Box Maximum Heat Dissipation Formula

Terminal box maximum heat dissipation

An ignition temperature is the temperature at which hot surface will cause an ignition to occur in a given atmosphere. Depending on the type of gas or dust, the maximum temperature, the surface of the terminal box can reach without a spontaneous ignition is known as the "T-Class". The maximum surface temperature must always be lower than the ignition temperature of the atmosphere in which it is used.

Each terminal box within the OSGP series has been assigned a maximum heat dissipation relating to the ambient and T Class.

The OSGP series offer T6 and T5 protection:

T6 = Maximum 85°C

T5 = Maximum 100°C

Resistance and temperature rise must be calculated as follows:

$$P = I^2 \times (R_t + R_c)$$

P[W] :Total heat dissipation.

I[A] :Maximum current at cables and terminals.

R_t [W] :Total resistance of terminals.

R_c [W] :Total resistance of cable(s).

*Each cable is internal maximum length measured diagonally across the terminal box.

$P \leq P_{max}$ condition must always be obtained.

MAXIMUM TERMINAL LOAD CONFIGURATION

For some applications, it may be necessary to have a variety of terminal sizes. The following tables and examples demonstrate how this is achieved. The power heat dissipation determines the maximum number of terminals permissible for any size of terminal box, based on a 100% load.

Example 1 : OSGP 5

Conductor size (mm ²)	Current (A)	Number of terminals	Load = 100% (Max.)
2.5	10	10(max:47)	21.27%
4.0	21	6(max:16)	37.5%
6.0	28	4(max:14)	28.57%

Total : 87.34%

Example 2 : OSGP 5

Conductor size (mm ²)	Current (A)	Number of terminals	Load = 100% (Max.)
2.5	16	10(max:18)	55.55%
4.0	21	2(max:16)	12.5%
10.0	37	5(max:12)	41.66%

Total : 109.71%

In example 2, the required size and number of terminals cannot be fitted into this terminal box because the total load has exceeded the maximum value of 100%.

In this case, a larger size terminal box must be chosen and the same steps should be repeated in order to keep the total load within 100% value.

OS-TOP Series Stainless Steel Terminal Junction Box

TYPICAL TERMINAL LOAD CONFIGURATION

The below given theoretical values are calculated depending on typical configurations. In any terminal box, the maximum heat dissipation power must not be exceeded. Maximum current value for terminals must be calculated with choosing the right T class and maximum ambient temperature.

TOP121209 (P_{max}: 4.85W)

Current (A)	Cross section(mm ²)			
	2.5	4	6	10
5				
8				
10				
16	12			
21		11		
28			10	
40				8

TOP 1515 (P_{max}: 5.1W)

Current (A)	Cross section(mm ²)			
	2.5	4	6	10
5				
8				
10				
16	9			
21		8		
28			7	
40				5

TOP 2020 (P_{max}: 7.66W)

Current (A)	Cross section(mm ²)					
	2.5	4	6	10	16	35
5						
8						
10						
16	29					
21	11	17				
28		10	15			
40			8	13		
50				6	9	
80					6	9
120						3

TOP 2626 (P_{max}: 12.94W)

Current (A)	Cross section(mm ²)						
	2.5	4	6	10	16	35	50
5							
8							
10	39						
16	15	23					
21		13	20				
28			11	18			
40				9	13	14	
80					8	5	9
120							4

TOP 3030 (P_{max}: 14.45W)

Current (A)	Cross section(mm ²)						
	2.5	4	6	10	16	35	50
5							
8							
10	39						
16	15	23					
21		13	20				
28			11	18			
40				9	13	15	
50					8	5	10
80							4
120							

TOP 2638 (P_{max}: 12.73W)

Current (A)	Cross section(mm ²)						
	2.5	4	6	10	16	35	50
5							
8							
10	32						
16	12	19					
21		11	17				
28			9	15			
40				7	11		
50					7	12	
80						4	8
120							3

TOP 4040 (P_{max}: 21.61W)

Current (A)	Cross section(mm ²)							
	2.5	4	6	10	16	35	50	70
5								
8								
10	46							
16	17	28						
21		16	24					
28			13	22				
40				11	16			
50					10	18		
80						7	12	
120							5	7
145								4

TOP 3550 (P_{max}: 19.61W)

Current (A)	Cross section(mm ²)							
	2.5	4	6	10	16	35	50	70
5								
8	61							
10	39	61						
16	15	24	36					
21		13	21	34				
28			11	19	28			
40				9	13	25		
50					8	16	26	
80						6	10	14
120							4	6
145								4

TOP 5050 (P_{max}: 24.97W)

Current (A)	Cross section(mm ²)							
	2.5	4	6	10	16	35	50	70
5								
8	68							
10	43	68						
16	17	26	40					
21		15	23	38				
28			13	21	32			
40				10	15	29		
50					10	18	30	
80						7	11	16
120							5	7
145								4

TOP 4562 (P_{max}: 30W)

Current (A)	Cross section(mm ²)							
	2.5	4	6	10	16	35	50	70
5								
8	75							
10	48	76						
16	18	29	45					
21		17	26	42				
28			14	24	35			
40				11	17	33		
50					11	21	33	
80						8	13	17
120							5	7
145								5

TOP 5574 (P_{max}: 37.14W)

Current (A)	Cross section(mm ²)							
	2.5	4	6	10	16	35	50	70
5	202							
8	79	125						
10	50	80	120					
16	19	31	47	77				
21		18	27	45	67			
28			15	25	38	73		
40				12	18	36	56	
50					11	23	35	49
80						9	14	19
120							6	8
145								5

TOP 6486 (P_{max}: 48.48W)

Current (A)	Cross section(mm ²)							
	2.5	4	6	10	16	35	50	70
5	230							
8	90	142						
10	57	91	137					
16	22	35	53	88				
21		20	31	51	78			
28			17	28	43	86		
40				14	21	42	64	
50					13	26	41	56
80						10	16	22
120							7	9
145								6

TOP 75100 (P_{max}: 67.09W)

Current (A)	Cross section(mm ²)							
	2.5	4	6	10	16	35	50	70
5	276							
8	108	171						
10	69	109	165					
16	27	42	64	106				
21		24	37	61	94			
28			21	34	53	105		
40				17	26	51	78	
50					16	33	49	69
80						12	19	27
120							8	12
145								8

TOP100100 (P_{max}: 75.38W)

Current (A)	Cross section(mm ²)							
	2.5	4	6	10	16	35	50	70
5	276							
8	107	171						
10	69	109	165					
16	26	42	64	106				
21		24	37	62	95			
28			21	34	53	107		
40				17	26	52	78	
50					16	33	50	69
80						13	19	27
120							8	12
145								8

TOP 80120 (P_{max}: 80.28W)

Current (A)	Cross section(mm ²)							
	2.5	4	6	10	16	35	50	70
5	285							
8	111	177						
10	71	113	170					
16	27	44	66	110				
21		25	38	64	98			
28			21	36	55	111		
40				17	27	54	81	
50					17	34	51	72
80						13	20	28
120							9	12
145								8

TOP 100120 (P_{max}: 92.05W)

Current (A)	Cross section(mm ²)							
	2.5	4	6	10	16	35	50	70
5	304							
8	118	189						
10	76	121	181					
16	29	47	71	117				
21		27	41	68	105			
28			23	38	59	119		
40				18	29	58	86	
50					18	37	55	77
80						14	21	30
120							9	13
145								9

TOP 100140 (P_{max}: 100.84W)

Current (A)	Cross section(mm ²)							
	2.5	4	6	10	16	35	50	70
5	304							
8	118	189						
10	76	121	182					
16	29	47	71	118				
21		27	41	68	105			
28			23	38	59	121		
40				18	29	59	87	
50					18	37	55	78
80						14	21	30
120							9	13
145								9

OS-TOP Series Stainless Steel Terminal Junction Box

Certificates



Classifications



[A TYPE]



[B TYPE]

- The material of OS-TOP is SS316L. Other materials can be produced at request.
- OS-TOP Mounting is designed to be easier and faster installation at site.
- Type A is designed to prevent from water getting into Junction Box by flat compression technique.
- Cable Gland and Junction Box can be ordered at one house.
- Silicon gasket is applied for longer last.
- Intrinsic safety(Ex ia) can be applied.
- All accessories of Junction Box is available.
- Control Junction Box can be obtained at request. (Unit Certificate)
- Removable gland plate is applied

Technical Information

Compliance Standard	IEC/EN 60079-0/60079-7-60079-11/60079-31
ATEX Certification	Presafe 18 ATEX 13653X
IECEX Certification	IECEX PRE 18.0083X
KCs Certification	19-KA2BO-0329~59X, 20-KA2BO-0312,13X
TR CU Certification	RU C-KR.AA87.B00251/19
PESO Certification	P465223
CCC Certification	2020332313000921
INMETRO Certification	DNV 21.0153X
Code of Protection	Ex eb IIC Gb, Ex tb IIIC T57°C/T72°C
Operating Temperature	-60°C ~ 110°C
Ambient Temperature	-60°C to +40°C for T6/T57°C -60°C to +55°C for T5/T72°C
Regulation	Zone 1,2 & 21,22, Gas Group IIA, IIB, IIC, Dust Group IIIA, IIIB, IIIC
Ingress Protection	IP 66 for OS-TOP [B TYPE] & IP66/67 for OS-TOP [A TYPE]
Junction Box Material	Stainless steel 304, 316, 316L with minimum thickness 1.5mm
Gasket Material	Silicon Rubber
Mounting	External mounting lug with 12mm holes of 4ea or 6ea at size
Earthing	Optional M8 internal/external earth stud, brass or stainless steel
Surface finish	Hairline(standard), electro polishing, etc.
Impact Resistance	7Nm(EN50014)

OS-TOP Series Stainless Steel Terminal Junction Box

Dimension

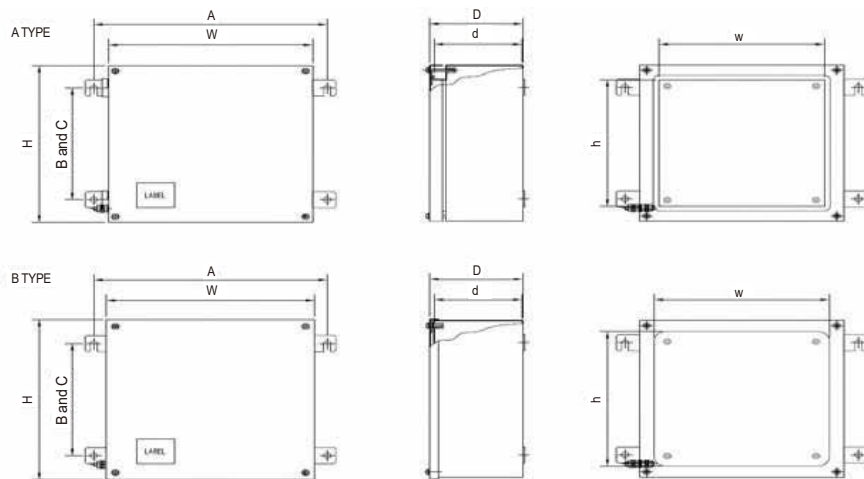

Dimension data Table for OS-TOP

* in millimeters

NO.	Part No. (** = D)	External Dimension(mm)			Internal Dimension(mm) Type A			Internal Dimension(mm) Type B			Mounting(mm)		
		W	H	D	W	H	D	w	h	d	A	B	C
1	121209B	122	120	90				95	93	83	170		
2				80						73			
3	1515**AorB	150	150	100	92	92	62	123	123	93	200		
4				120			102			113			
5	2020**AorB	200	200	120	133	133	102	170	170	113	250		
6				160			142			153			
7	2626**AorB	260	260	160	193	193	142	230	230	153	310	160	
8				200			182			193			
9	3030**AorB	300	300	160	233	233	142	270	270	153	350	200	
10				200			182			193			
11	2638**AorB	260	380	160	193	313	142	230	350	153	310	280	
12				200			182			193			
13	4040**AorB	400	400	160	333	333	142	370	370	153	450	300	
14				200			182			193			
15				160			142			153			
16	3550**AorB	350	500	200	283	433	182	320	450	193	400	400	
17				250			232			243			
18				160			142			153			
19	5050**AorB	500	500	200	433	433	182	450	450	193	550	400	
20				250			232			243			
21				200			182			193			
22	4562**AorB	450	620	250	383	553	232	400	570	243	500	520	
23				300			282			293			
24				200			182			193			
25	5574**AorB	550	740	250	483	673	232	500	690	243	600	640	
26				300			282			293			
27				200			182			193			
28	6486**AorB	640	860	250	573	793	232	590	810	243	690	760	
29				300			282			293			
30				200			182			193			
31	75100**AorB	750	1000	250	683	933	232	700	950	243	800	900	
32				300			282			293			
33				200			182			193			
34	100100**AorB	1000	1000	250	933	933	232	950	950	243	1050	900	
35				300			282			293			
36				300			282			293			
37	80120**AorB	800	1200	400	733	1133	382	750	1150	393	850	550	550
38				500			482			493			
39				300			282			293			
40	100140**AorB	1000	1400	400	933	1333	382	950	1350	393	1050	650	650
41				500			482			493			

※ Intermediate size between 150x150x80 and 1000x1400x500 can be manufactured, but the specification follows the lower sizes

※ MDP value is available on the certificates of IECEx PRE 18,0083X and Presafe 18 ATEX 13653X.

※ Due to the two different designs, Part number must indicate A or B with exact Depth size.

※ Mounting bolt size is 12Ø for all sizes of stainless steel junction box.

※ External Dimension W and H can be positioned differently.

※ B type's cover is +7mm wider than A type

OS-TOP Series Stainless Steel Terminal Junction Box

I Physical maximum terminal capacity

TYPE	2.5 SQ	4 SQ	6 SQ	10 SQ	16 SQ	35 SQ	50 SQ	70/95 SQ
1212	1 x 8	1 x 6	1 x 5	1 x 4				
1515	1 x 10	1 x 8	1 x 6	1 x 5				
2020	1 x 20	1 x 16	1 x 13	1 x 10	1 x 8	1 x 6		
2626	1 x 31	1 x 26	1 x 20	1 x 16	1 x 13	1 x 10	1 x 9	
3030	1 x 39	1 x 33	1 x 25	1 x 20	1 x 17	1 x 13	1 x 11	
2638	1 x 55	1 x 46	1 x 35	1 x 28	1 x 24	1 x 18	1 x 15	
4040	2 x 59	2 x 49	2 x 38	2 x 30	2 x 25	2 x 19	2 x 16	2 x 15
3550	2 x 78	2 x 66	2 x 51	2 x 40	2 x 34	2 x 25	2 x 22	2 x 20
5050	3 x 78	3 x 66	3 x 51	3 x 40	3 x 34	3 x 25	3 x 22	3 x 20
4562	3 x 102	3 x 85	3 x 66	3 x 53	3 x 44	3 x 33	3 x 28	3 x 25
5574	4 x 125	4 x 105	4 x 81	4 x 65	4 x 54	4 x 40	4 x 35	4 x 31
6486	5 x 149	5 x 125	5 x 96	5 x 77	5 x 64	5 x 48	5 x 41	5 x 37
75100	5 x 176	5 x 148	5 x 114	5 x 91	5 x 76	5 x 56	5 x 49	5 x 44
100100	6 x 176	6 x 148	6 x 114	6 x 91	6 x 76	6 x 56	6 x 49	6 x 44
80120	6 x 216	6 x 180	6 x 139	6 x 111	6 x 92	6 x 69	6 x 59	6 x 54
100120	6 x 216	6 x 180	6 x 139	6 x 111	6 x 92	6 x 69	6 x 59	6 x 54
100140	6 x 255	6 x 213	6 x 165	6 x 131	6 x 109	6 x 81	6 x 70	6 x 63

※ Terminal block is WDU series or equivalent products.

I Maximum Cable entry quantity

TYPE	ENTRY POSITION	M16	M20	M25	M32	M40	M50	M63	M75
121209	Top / Bottom	4	3	2	1	1	-	-	-
	Left / Right	3	2	1	1	1	-	-	-
151510	Top / Bottom	8	4	3	2	2	-	-	-
	Left / Right	6	3	2	1	1	-	-	-
202012	Top / Bottom	14	8	6	3	3	2	-	-
	Left / Right	10	6	5	3	2	1	-	-
262616	Top / Bottom	26	15	12	8	6	3	2	2
	Left / Right	22	12	9	6	5	2	1	1
303016	Top / Bottom	30	18	13	10	7	4	3	2
	Left / Right	28	15	12	8	6	3	2	2
263816	Top / Bottom	26	15	12	8	6	3	2	2
	Left / Right	36	21	15	10	8	4	3	2
404016	Top / Bottom	42	24	18	12	10	5	4	3
	Left / Right	38	21	16	12	9	4	3	3
355016	Top / Bottom	38	21	16	11	9	4	3	2
	Left / Right	50	28	21	14	12	6	4	3
505016	Top / Bottom	54	31	24	16	13	6	5	4
	Left / Right	50	28	21	14	12	6	4	3
456220	Top / Bottom	60	38	28	21	12	10	6	4
	Left / Right	80	50	36	27	17	12	7	5
557420	Top / Bottom	75	46	34	25	15	12	7	4
	Left / Right	97	60	44	33	20	16	9	6
648620	Top / Bottom	87	54	40	30	18	14	8	5
	Left / Right	115	70	52	39	23	18	11	7
7510020	Top / Bottom	102	64	48	36	21	16	10	6
	Left / Right	135	82	68	46	29	22	13	8
10010020	Top / Bottom	140	86	64	48	28	22	13	9
	Left / Right	135	82	68	46	29	22	13	8
8012030	Top / Bottom	176	102	93	62	37	37	21	12
	Left / Right	260	150	126	92	55	39	31	18
10012030	Top / Bottom	224	129	129	80	47	33	27	16
	Left / Right	260	150	126	92	55	39	31	18
10014030	Top / Bottom	224	129	129	80	47	33	27	16
	Left / Right	308	177	147	110	65	45	37	22

OS-ITOP Series Stainless Steel Terminal Junction Box



- The material of OS-ITOP is SS316L. Other materials can be produced at request.
- OS-ITOP Mounting is designed to be easier and faster installation at site.
- Type A is designed to prevent from water getting into Junction Box by flat compression technique.
- Cable Gland and Junction Box can be ordered at one house.
- Silicon gasket is applied for longer last.
- All accessories of Junction Box is available.
- Control Junction Box can be obtained at request. (Unit Certificate)
- Removable gland plate is applied

Technical Information

Operating Temperature	-60°C ~ 110°C
Ingress Protection	IP 66 for OS-ITOP [B TYPE] & IP66/67 for OS-ITOP [A TYPE]
Junction Box Material	Stainless steel 304, 316, 316L with minimum thickness 1.5mm
Gasket Material	CR
Mounting	External mounting lug with 12mm holes of 4ea or 6ea at size
Earthing	Optional M8 internal/external earth stud, brass or stainless steel
Surface finish	Hairline(standard), electro polishing, etc.
Impact Resistance	7Nm(EN50014)

OS-ITOP Series Stainless Steel Terminal Junction Box

Dimension

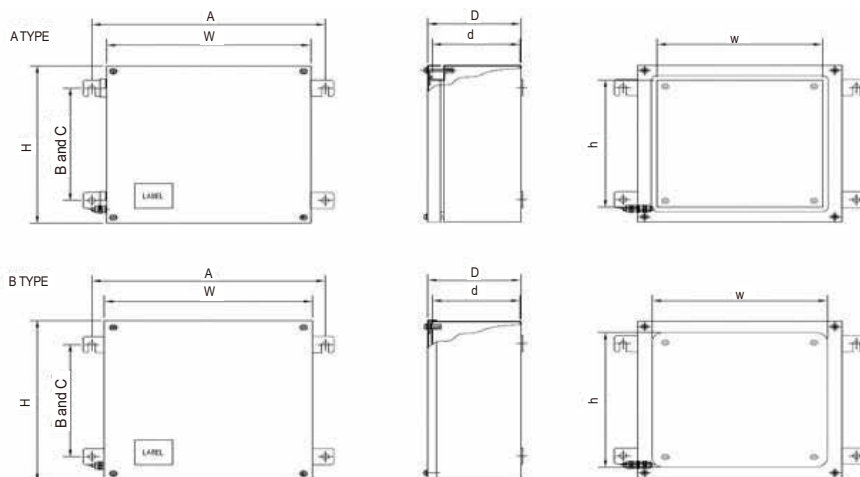

Dimension data Table for OS-ITOP

* in millimeters

NO.	Part No. (** = D)	External Dimension(mm)			Internal Dimension(mm) Type A			Internal Dimension(mm) Type B			Mounting(mm)		
		W	H	D	W	H	D	w	h	d	A	B	C
1	121209B	122	120	90				95	93	83	170		
2				80			62			73			
3	1515**AorB	150	150	100	92	92	82	123	123	93	200		
4				120			102			113			
5	2020**AorB	200	200	120	133	133	102	170	170	113	250	160	
6				160			142			153			
7	2626**AorB	260	260	160	193	193	142	230	230	153	310	160	
8				200			182			193			
9	3030**AorB	300	300	160	233	233	142	270	270	153	350	200	
10				200			182			193			
11	2638**AorB	260	380	160	193	313	142	230	350	153	310	280	
12				200			182			193			
13	4040**AorB	400	400	160	333	333	142	370	370	153	450	300	
14				200			182			193			
15				160			142			153			
16	3550**AorB	350	500	200	283	433	182	320	450	193	400	400	
17				250			232			243			
18				160			142			153			
19	5050**AorB	500	500	200	433	433	182	450	450	193	550	400	
20				250			232			243			
21				200			182			193			
22	4562**AorB	450	620	250	383	553	232	400	570	243	500	520	
23				300			282			293			
24				200			182			193			
25	5574**AorB	550	740	250	483	673	232	500	690	243	600	640	
26				300			282			293			
27				200			182			193			
28	6486**AorB	640	860	250	573	793	232	590	810	243	690	760	
29				300			282			293			
30				200			182			193			
31	75100**AorB	750	1000	250	683	933	232	700	950	243	800	900	
32				300			282			293			
33				200			182			193			
34	100100**AorB	1000	1000	250	933	933	232	950	950	243	1050	900	
35				300			282			293			
36				300			282			293			
37	80120**AorB	800	1200	400	733	1133	382	750	1150	393	850	550	550
38				500			482			493			
39				300			282			293			
40	100140**AorB	1000	1400	400	933	1333	382	950	1350	393	1050	650	650
41				500			482			493			

※ Intermediate size between 150x150x80 and 1000x1400x500 can be manufactured, but the specification follows the lower sizes
 ※ Due to the two different designs, Part number must indicate A or B with exact Depth size.
 ※ Mounting bolt size is 12Ø for all sizes of stainless steel junction box.
 ※ External Dimension W and H can be positioned differently.
 ※ B type's cover is +7mm wider than A type

OSGP Series Glass Fibre Reinforced Polyester Terminal Junction Box

TYPICAL TERMINAL LOAD CONFIGURATION

The below given theoretical values are calculated depending on typical configurations. In any terminal box, the maximum heat dissipation power must not be exceeded. Maximum current value for terminals must be calculated with choosing the right T class and maximum ambient temperature.

OSGP 1 (P max : 6.17W)

Current (A)	Cross section(mm ²)						
	2.5	4	6	10	16	25	35
5							
8							
10							
16	14						
21		12					
28			11				
37							
50							
60							
70							

OSGP 6 (P max : 18.03W)

Current (A)	Cross section(mm ²)						
	2.5	4	6	10	16	25	35
5							
8							
10	58						
16	22	35					
21		20	31				
28			17	27			
37				15	22		
50					12	16	20
60						11	14
70							10

OSGP 2 (P max : 9.78W)

Current (A)	Cross section(mm ²)						
	2.5	4	6	10	16	25	35
5							
8							
10	48						
16	18	28					
21		16	25				
28			14	22			
37				12			
50							
60							
70							

OSGP 7 (P max : 21.87W)

Current (A)	Cross section(mm ²)						
	2.5	4	6	10	16	25	35
5							
8							
10	57						
16	22	34					
21		20	30				
28			17	27			
37				15	22		
50					12	17	21
60						12	15
70							11

OSGP 3 (P max : 12.23W)

Current (A)	Cross section(mm ²)						
	2.5	4	6	10	16	25	35
5							
8							
10	47						
16	18	28	43				
21		16	25	39			
28			14	22			
37				12			
50							
60							
70							

OSGP 8 (P max : 23.34W)

Current (A)	Cross section(mm ²)						
	2.5	4	6	10	16	25	35
5							
8							
10	59						
16	23	36					
21		21	32				
28			18	29			
37				16	23		
50					13	18	23
60						12	16
70							11

OSGP 4 (P max : 14.89W)

Current (A)	Cross section(mm ²)						
	2.5	4	6	10	16	25	35
5							
8							
10	45						
16	17	27	42				
21		16	24	39			
28			13	22			
37				12			
50							
60							
70							

OSGP 9 (P max : 28.98W)

Current (A)	Cross section(mm ²)						
	2.5	4	6	10	16	25	35
5							
8	100						
10	64						
16	25	39	59				
21		22	34	56			
28			19	31	45		
37				18	26	36	
50					14	20	25
60						14	17
70							13

OSGP 5 (P max : 16.17W)

Current (A)	Cross section(mm ²)						
	2.5	4	6	10	16	25	35
5							
8							
10	53						
16	21	32					
21		18	28				
28			16	25			
37				14	20		
50					11	15	19
60						10	13
70							9

OSGP 10 (P max : 31.03W)

Current (A)	Cross section(mm ²)									
	2.5	4	6	10	16	25	35	50	70	95
5										
8	106									
10	67									
16	26	41	62							
21		24	36	59						
28			20	33	48					
37				19	27	39				
50					15	21	27			
60						14	18	23		
70							13	17		
95								9		
120									7	10
150										8

Any number of conductors and terminals additionally.
 To be engineered by the manufacturer.

OSGP 11 (P max : 31.03W)

Current (A)	Cross section(mm ²)									
	2.5	4	6	10	16	25	35	50	70	95
5										
8	106									
10	67									
16	26	41	62							
21		24	36	59						
28			20	33	48					
37				19	27	39				
50					15	21	27			
60						14	18	23		
70							13	17		
95								9		
120									7	10
150										8

OSGP Series Glass Fibre Reinforced Polyester Terminal Junction Box

Certificates	      
Classifications	



- The material of OSGP is glass fibre reinforced polyester. Black color is only available with explosion proof.
- Cable Gland and Junction Box can be ordered at one house.
- Silicon gasket is applied for longer last.
- Intrinsic safety(Ex ia) can be applied.
- All accessories of Junction Box are available.
- Control Junction Box can be obtained at request. (Unit Certificate)

Technical Information

Compliance Standard	IEC/EN 60079-0/60079-7-60079-11/60079-31
ATEX Certification	Presafe 17 ATEX 11238X
IECEX Certification	IECEX PRE 17.0054X
KCs Certification	18-KA2BO-0206~11X, 18-KA2BO-0222~35X
TR CU Certification	RU C-KR.AA87.B 01105
PESO Certification	P465223
CCC Certification	2020332313000855
INMETRO Certification	DNV 21.0146X
Code of Protection	Ex eb IIC Gb, Ex tb IIIC T57°C/T72°C
Operating Temperature	-60°C ~ 110°C
Ambient Temperature	-60°C to +40°C for T6/T57°C -60°C to +55°C for T5/T72°C
Regulation	Zone 1,2 & 21,22, Gas Group IIA, IIB, IIC, Dust Group IIIA, IIIB, IIIC
Ingress Protection	IP66/67
Junction Box Material	Glass Fibre Reinforced Polyester(GRP)
Gasket Material	Silicon Rubber
Mounting	Integral 6mm clearance holes moulded into the body
Earthing	Optional M6 internal/external earth stud, brass or stainless steel
UV Protection	1000hr (IEC 60079-0 26.10)
Impact Resistance	7Nm(EN50014)
Color	RAL 9005 Black
Toxicity	Low Smoke Halogen Free V-0 Self-Extinguishing, UL94
Surface Insulation Resistance	10 ⁹ Ohm ≤black ≤10 ⁹ Ohm UV Protection
Earth Plate	Optional at request

OSGP Series Glass Fibre Reinforced Polyester Terminal Junction Box

Dimensions

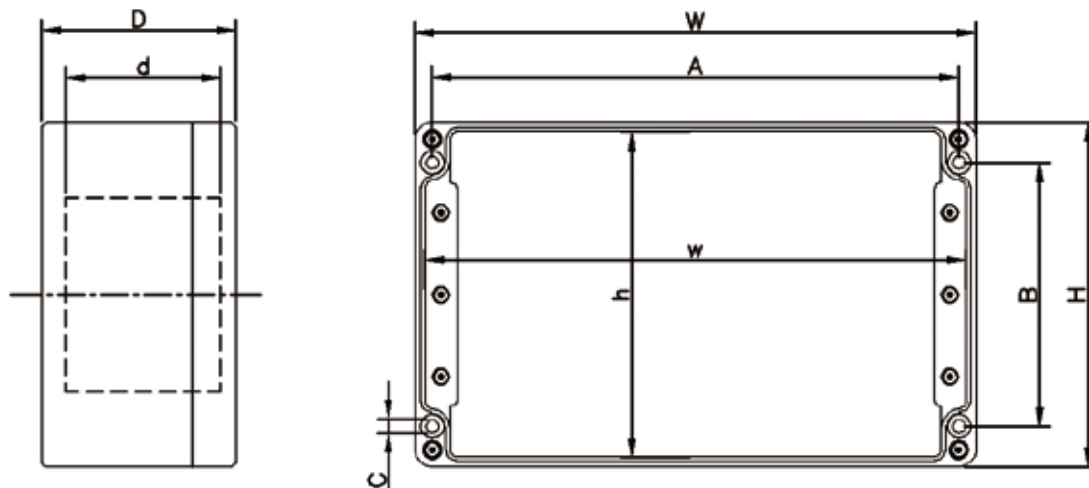

Legend

W : External wide
H : External height
D : External depth

w : Internal wide
h : Internal height
d : Internal depth

A : Horizontal fixing hole distance
B : Vertical fixing hole distance
C : Fixing hole diameter

Dimensions Data Table

TYPE	External dimension [mm]			Internal dimension [mm]			Mounting [mm]			Weight [kg]	Max. dissipation power [W]
	W	H	D	w	h	d	A	B	C		
OSGP 1	122	120	90	113	111	72	106	82	6.5	0.75	6.17
OSGP 2	160	160	90	151	151	77	140	110	6.5	1.10	9.78
OSGP 3	260	160	90	251	151	77	240	110	6.5	1.20	12.23
OSGP 4	360	160	90	351	151	77	340	110	6.5	2.20	14.89
OSGP 5	255	250	120	243	238	111	235	200	6.5	3.00	16.17
OSGP 6	255	250	160	243	238	149	235	200	6.5	3.50	18.03
OSGP 7	400	250	120	388	238	111	380	200	6.5	4.40	21.87
OSGP 8	400	250	160	388	238	149	380	200	6.5	5.00	23.34
OSGP 9	405	400	120	393	388	111	385	350	6.5	6.00	28.98
OSGP 10	405	400	160	393	388	149	385	350	6.5	6.70	31.03
OSGP 11	405	400	200	393	388	187	385	350	6.5	7.30	31.03

OSGP Series Glass Fibre Reinforced Polyester Terminal Junction Box

I Physical maximum terminal capacity

TYPE	2.5 SQ	4 SQ	6 SQ	10 SQ	16 SQ	35 SQ	50 SQ	70/95 SQ
OSGP 1	1 x 12	1 x 10	1 x 8	1 x 6	1 x 5	1 x 4	-	-
OSGP 2	1 x 19	1 x 16	1 x 12	1 x 10	1 x 8	1 x 5	-	-
OSGP 3	1 x 39	1 x 32	1 x 25	1 x 20	1 x 16	1 x 12	-	-
OSGP 4	1 x 58	1 x 48	1 x 37	1 x 30	1 x 24	1 x 18	-	-
OSGP 5	2 x 38	2 x 32	2 x 25	2 x 20	2 x 16	2 x 12	-	-
OSGP 6	2 x 38	2 x 32	2 x 25	2 x 20	2 x 16	2 x 12	-	-
OSGP 7	2 x 66	2 x 55	2 x 43	2 x 34	2 x 28	2 x 21	-	-
OSGP 8	2 x 66	2 x 55	2 x 43	2 x 34	2 x 28	2 x 21	-	-
OSGP 9	3 x 67	3 x 56	3 x 43	2 x 35	2 x 28	2 x 21	-	-
OSGP 10	3 x 67	3 x 56	3 x 43	2 x 35	2 x 28	2 x 21	2 x 18	1 x 12
OSGP 11	3 x 67	3 x 56	3 x 43	2 x 35	2 x 28	2 x 21	2 x 18	1 x 12

※ Terminal block is WDU series or equivalent products.

I Maximum Cable entry quantity

TYPE	ENTRY POSITION	M16	M20	M25	M32	M40	M50	M63	M75
OSGP 1	Top / Bottom	2	2	2	1	-	-	-	-
	Left / Right	1	1	1	1	-	-	-	-
OSGP 2	Top / Bottom	4	3	2	2	-	-	-	-
	Left / Right	3	2	2	1	-	-	-	-
OSGP 3	Top / Bottom	9	5	4	3	-	-	-	-
	Left / Right	3	2	2	1	-	-	-	-
OSGP 4	Top / Bottom	14	8	6	5	-	-	-	-
	Left / Right	3	2	2	1	-	-	-	-
OSGP 5	Top / Bottom	14	10	7	4	3	2	-	-
	Left / Right	10	7	5	3	2	1	-	-
OSGP 6	Top / Bottom	22	11	8	6	5	2	2	1
	Left / Right	14	9	6	6	3	2	1	1
OSGP 7	Top / Bottom	21	15	12	6	4	3	-	-
	Left / Right	9	7	4	3	2	1	-	-
OSGP 8	Top / Bottom	29	23	15	11	9	4	3	2
	Left / Right	14	11	6	6	3	2	1	1
OSGP 9	Top / Bottom	20	14	12	7	5	3	-	-
	Left / Right	17	12	9	6	4	3	-	-
OSGP 10	Top / Bottom	40	23	15	11	9	4	3	2
	Left / Right	26	20	14	9	6	3	2	1
OSGP 11	Top / Bottom	48	27	18	14	10	5	3	2
	Left / Right	32	23	17	11	18	5	2	1

OSIGP Series Glass Fibre Reinforced Polyester Terminal Junction Box

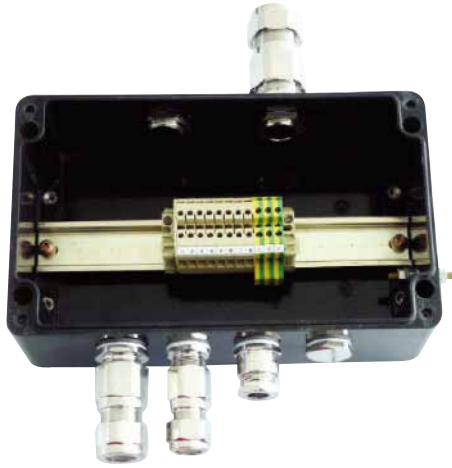

Technical Information

Ingress Protection	IP66/67
Junction Box Material	Glass Fibre Reinforced Polyester(GRP)
Gasket Material	Silicon Rubber
Mounting	Integral 6mm clearance holes moulded into the body
Earthing	Optional M6 internal/external earth stud, brass or stainless steel
UV Protection	1000hr (IEC 60079-0 26.10)
Impact Resistance	7Nm(EN50014)
Color	RAL 9005 Black RAL 7001 Gray(option-BMC material) RAL 3001 Gray(option-BMC material)
Toxicity	Low Smoke Halogen Free V-0 Self-Extinguishing, UL94
Surface Insulation Resistance	$10^6\text{Ohm} \leq \text{black} \leq 10^9\text{Ohm}$ UV Protection
Earth Plate	Optional at request

OSIGP Series Glass Fibre Reinforced Polyester Terminal Junction Box

I Dimension

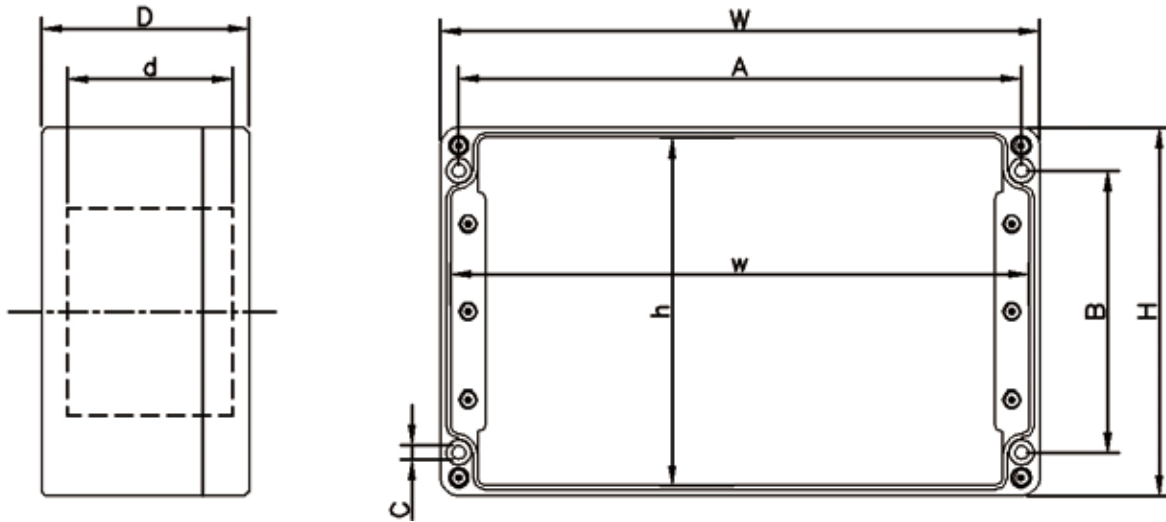

I Legend

W : External wide
H : External height
D : External depth

w : Internal wide
h : Internal height
d : Internal depth

A : Horizontal fixing hole distance
B : Vertical fixing hole distance
C : Fixing hole diameter

I Dimensions Data Table

TYPE	External dimension [mm]			Internal dimension [mm]			Mounting [mm]			Weight [kg]
	W	H	D	w	h	d	A	B	C	
OSIGP 1	122	120	90	113	111	72	106	82	6.5	0.75
OSIGP 2	160	160	90	151	151	77	140	110	6.5	1.10
OSIGP 3	260	160	90	251	151	77	240	110	6.5	1.20
OSIGP 4	360	160	90	351	151	77	340	110	6.5	2.20
OSIGP 5	255	250	120	243	238	111	235	200	6.5	3.00
OSIGP 6	255	250	160	243	238	149	235	200	6.5	3.50
OSIGP 7	400	250	120	388	238	111	380	200	6.5	4.40
OSIGP 8	400	250	160	388	238	149	380	200	6.5	5.00
OSIGP 9	405	400	120	393	388	111	385	350	6.5	6.00
OSIGP 10	405	400	160	393	388	149	385	350	6.5	6.70
OSIGP 11	405	400	200	393	388	187	385	350	6.5	7.30

Maximum terminal quantity

TYPE	2.5 SQ	4 SQ	6 SQ	10 SQ	16 SQ	35 SQ
OSIGP 1	1 x 12	1 x 10	1 x 8	1 x 6	1 x 5	1 x 4
OSIGP 2	1 x 19	1 x 16	1 x 12	1 x 10	1 x 8	1 x 5
OSIGP 3	1 x 39	1 x 32	1 x 25	1 x 20	1 x 16	1 x 12
OSIGP 4	1 x 58	1 x 48	1 x 37	1 x 30	1 x 24	1 x 18
OSIGP 5	2 x 38	2 x 32	2 x 25	2 x 20	2 x 16	2 x 12
OSIGP 6	2 x 38	2 x 32	2 x 25	2 x 20	2 x 16	2 x 12
OSIGP 7	2 x 66	2 x 55	2 x 43	2 x 34	2 x 28	2 x 21
OSIGP 8	2 x 66	2 x 55	2 x 43	2 x 34	2 x 28	2 x 21
OSIGP 9	3 x 67	3 x 56	3 x 43	2 x 35	2 x 28	2 x 21
OSIGP 10	3 x 67	3 x 56	3 x 43	2 x 35	2 x 28	2 x 21
OSIGP 11	3 x 67	3 x 56	3 x 43	2 x 35	2 x 28	2 x 21

Used Terminal Block Information

TB Type	Rated voltage (V)	Rated current (A)	Max. current/ conductor (A/mm ²)	Tightening torque (Nm)	Stripping length (mm)
2.5SQ	550	21	23/2.5	0.4~0.8(M2.5)	10
4SQ	690	28	41/6	0.5~1.0(M3)	10
6SQ	550	36	57/10	0.8~1.6(M3.5)	12
10SQ	550	50	76/16	1.2~2.4(M4)	12
16SQ	690	66	101/25	3.0~4.0(M5)	16
35SQ	690	109	150/50	4.5~5.0(M6)	18
50SQ	690	126	192/70	3.5~6.0(M6)	24
70/95SQ	1100	218	232/120	6.0~12(M8)	30

Maximum Cable entry quantity

TYPE	ENTRY POSITION	M16	M20	M25	M32	M40	M50	M63	M75
OSIGP 1	Top / Bottom	2	2	2	1	-	-	-	-
	Left / Right	1	1	1	1	-	-	-	-
OSIGP 2	Top / Bottom	4	3	2	2	-	-	-	-
	Left / Right	3	2	2	1	-	-	-	-
OSIGP 3	Top / Bottom	9	5	4	3	-	-	-	-
	Left / Right	3	2	2	1	-	-	-	-
OSIGP 4	Top / Bottom	14	8	6	5	-	-	-	-
	Left / Right	3	2	2	1	-	-	-	-
OSIGP 5	Top / Bottom	14	10	7	4	3	2	-	-
	Left / Right	10	7	5	3	2	1	-	-
OSIGP 6	Top / Bottom	22	11	8	6	5	2	2	1
	Left / Right	14	9	6	6	3	2	1	1
OSIGP 7	Top / Bottom	21	15	12	6	4	3	-	-
	Left / Right	9	7	4	3	2	1	-	-
OSIGP 8	Top / Bottom	29	23	15	11	9	4	3	2
	Left / Right	14	11	6	6	3	2	1	1
OSIGP 9	Top / Bottom	20	14	12	7	5	3	-	-
	Left / Right	17	12	9	6	4	3	-	-
OSIGP 10	Top / Bottom	40	23	15	11	9	4	3	2
	Left / Right	26	20	14	9	6	3	2	1
OSIGP 11	Top / Bottom	48	27	18	14	10	5	3	2
	Left / Right	32	23	17	11	8	5	2	1

TECHNICAL

CABLE GLAND / JUNCTION BOX hazardous & industrial area

| BS 6121 TYPE OF GLAND

Type A1	For unarmoured cable with an elastomeric or plastics outer sheath, where the function of the gland is to secure the outer sheath of the cable.
Type A2	As type A1, but with an IP66 seal between the outer sheath and gland.
Type B	For armoured or wire braided cable, where the function of the gland is to secure the armour or metallic braid and to provide electrical continuity between such armour or braid and the threaded fixing component of the gland.
Type C	For armoured or wire braided cable with elastomeric or plastics outer sheath. As type B, but with an IP66 seal between outer sheath and gland.
Type E1	For armoured or wire braided cable with an extruded elastomeric or plastics inner sheath and elastomeric or plastics outer sheath. As type B, but with IP66 seals between the outer sheath and gland and between the inner sheath and threaded fixing component.

The suffix for each type of protection shall be as follows.

Single wire armoured	W
Pliable wire armoured flexible	T
Wire braided	X

Aluminium strip armoured	Y
Double steel tape armoured	Z

EMC(BS6121 - EN 50262 Table 1. Test Requirements)

Electromagnetic Compatibility	No test required (glands are considered passive)
-------------------------------	---

| ColdFlow

IEC 60079-14, 10.2 Selection of cable glands

The cable gland shall be selected to match the cable diameter. The use of sealing tape, heat shrink tube or other materials is not permitted to make the cable fit to the cable gland.

Cable glands and/or cables shall be selected to reduce the effects of "coldflow characteristics" of the cable.

NOTE 1 Cables employ materials which could exhibit "coldflow" characteristics. Coldflow in cables can be described as the movement of the cable sheath under the compressive forces created by the displacement of seals in cable glands where the compressive force applied by the seal is greater than the resistance of the cable sheath to deformation. Coldflow could give rise to a reduction in the insulation resistance of the cable. Low smoke and/or fire resistant cables usually exhibit significant cold flow characteristics.

TEMPERATURE CLASSIFICATION & GAS GROUPINGS

Flammable mixtures can be classified under two main characteristics in respect of explosion protection; temperature of ignition by hot surfaces and the spark energy required to ignite the mixture. The spark energy of the ignition is also related to the intensity of the explosion. Classification of maximum surface temperatures in both North America and Europe are similar but vary slightly in the nomenclature used. The temperature classification is important to ensure that the correct equipment is matched to the flammable atmosphere that could potentially exist in an area. This will take into account such things as maximum ambient temperature and maximum operating voltage with a + 10% over voltage or an overload condition applied. In some types of protection such as Ex 'd' or 'nR' the temperature classification is based on the outside temperature of the enclosure whereas in other types of protection such as Ex 'e' or 'nA' the temperature classification is based on the temperature of the internal components.

TEMPERATURE CLASSIFICATION

(Unless otherwise specified on the rating plate it is assumed that the operating ambient temperature is in the range -20oC to + 40oC in accordance with European standards) All gases are grouped according to their physical properties and details of their grouping can be found in either National or International codes of practice. Some examples of Gas Groups are shown below.

Maximum surface Temperature	US(NEC 505) IEC CENELEC	US(NEC 500)	Maximum surface Temperature	US(NEC 505) IEC CENELEC	US(NEC 500)
450°C	T1	T1	180°C	T3	T3A
300°C		T2	165°C		T3B
280°C	T2	T2A	160°C	T4	T3C
260°C		T2B	135°C		T4
230°C		T2C	120°C		T4A
215°C		T2D	100°C	T5	
200°C	T3	T3	85°C	T6	T6

TECHNICAL

CABLE GLAND / JUNCTION BOX hazardous & industrial area

I GAS GROUPING FOR ELECTRICAL APPARATUS(EN 50014)

GROUP	GAS
I(Mining)	Methane(firedamp)
IIA	Industrial methane, propane, petrol & most industrial gases.
IIB	Ethylene, Town gas & other industrial gases
IIC	Hydrogen, Acetylene & Carbon Di-sulphide

Ambient Temperature

The ambient temperature is the surrounding temperature of the environment in which the equipment is installed, whether indoors or outdoors. For electrical equipment certified in Europe it is assumed that the ambient temperature in which the equipment may be operated is between -20°C to + 40°C. Some types of equipment are certified for operation outside this range and if so must be stated on the equipment label or certificate.

I ATEX DIRECTIVE

The ATEX directive came into force in April 1994 and was enacted into UK law in March 1996. It became a mandatory requirement in July 2003. Most of the products in this catalogue have an EC type examination certificate to the ATEX directive. ATEX covers both electrical and mechanical ignition hazards. Apparatus are divided into equipment groups (I for mining and II non-mining), source of ignition Gas(G) and Dust(D) and Categories 1, 2 and 3. The categories provide respectively, very high, high and normal levels of protection against ignition. The categories deliver the level of protection which is currently obtained by applying the existing protection techniques(Ex 'd', Ex 'e' etc) and they also take into account other protection concepts proposed by manufacturers and considered by the notified(certification) bodies who produce EC type examination(ATEX) Certificates. The categories in practice are equated to suitability for Zones. The actual category of apparatus specified for a Zone depends on the overall risk assessment for a Zone. The zoning considers only the probability of the existence of an explosive atmosphere. It does not consider the consequential effects of an ignition taking place. Apparatus are marked with the grouping and category in addition to the marking required by the individual protection standards.

I NORTH AMERICAN STANDARDS

Although this code change permits the use of products that have a Zonal classification, in a similar way to European practice, mixing of different forms of equipment approval across zones or divisions is not acceptable. e. g. products approved for Zone 1 do not necessarily meet the requirements of Division 1, which also encompasses Zone 0. Although no direct equivalents exist between European/IEC and American codes of protection and Area Classification there are similarities and there is a developing acceptance of European/IEC methods in North America and vice versa. The following table shows the basic relationships between the North American and European classifications.

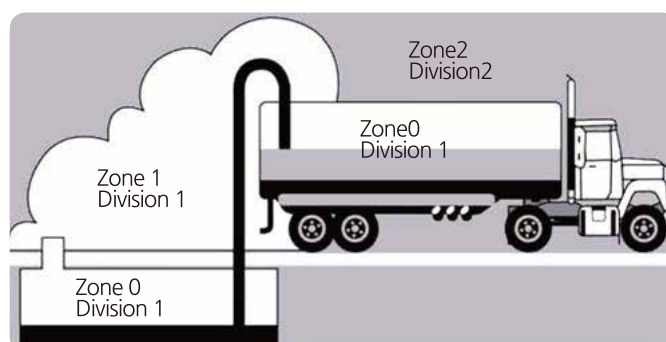

EQUIVALENT DIVISION / ZONE

	Flammable gas always present 1000 hrs/year	Flammable gas normally present 10-1000 hrs/year	Flammable gas not normally present 10 hrs/year
CENELEC/IEC	Zone 0 (Zone 20 dust)	Zone 1 (Zone 21 dust)	Zone 2 (Zone 22 dust)
ATEX	Category 1G Category 1D	Category 2G Category 2GAS	Category 3G Category 3D
US-NEC 505	Zone 0	Zone 1	Zone 2
US-NEC 500	Division 1	Division 1	Division 2

As can be seen from the table above, Division I covers both the European/IEC Zones 0 & 1. Therefore, care must be taken when using zone classified equipment in a Division 1 area as to the suitability of the protection employed. Underwriters Laboratory(UL) and Factory Mutual Inc(FM) are two main certification bodies in North America and in some cases, electrical equipment may also need to meet certain Marine Standards, and be separately approved by the US Coast Guards, before it can be used e.g. on an offshore oil rig.

PROTECTION CONCEPTS

Method of Protection	Symbol	Permitted Zone	ATEX Category	CENELEC Standard	IEC Standard	Protection Principle
Flameproof	Ex d	1 & 2	2& 3	EN 50018	60079-1	Contain the explosion and prevent transmission
Enclosed Break	Ex nC	2	3	EN 50021	60079-15	
Powder Filled	Ex q	1 & 2	2& 3	EN 50017	60079-5	
Increased Safety	Ex e	1 & 2	2& 3	EN 50019	60079-7	No Arcs, sparks of hot surfaces or components
Non Sparking	Ex nA	2	3	EN 50021	60079-15	
Intrinsic Safety	Ex ia	0,1 & 2	1, 2& 3	EN 50020	60079-11	Limit energy of sparks and limit temperature of hot surfaces or components
	Ex ib	1 & 2	2& 3	EN 50020	60079-11	
Energy Limitation	Ex nL	2	3	EN 50021	60079-15	
Pressurised	Ex p	1 & 2	2& 3	EN 50016	60079-2	Prevent flammable gas coming into contact with hot surfaces and ignition capable equipment
Encapsulation	Ex m	1 & 2	2& 3	EN 50028	60079-18	
Oil Immersion	Ex o	1 & 2	2& 3	EN 50015	60079-6	
Restricted Breathing	Ex nR	2	3	EN 50021	60079-15	
Special	Ex s	0,1 & 2	1, 2& 3	EHSR		Any proven method
Dust ignition proof	Ex t	20, 21 & 22	1,2 & 3	EN 61241-1	60079-31	Dust ignition protection

INGRESS PROTECTION

A major secondary protection parameter is the ingress protection of the electrical equipment. Moisture or dust if allowed to come into contact with electrical circuits could lead to either sparking or physical breakdown of the components and interfere with the protection method being used. In some cases the IP ratings for products in this catalogue have been carried out in accordance with EN 60529 (IEC 529) and have been witness tested by independent test laboratories. It will be noted that some products have both IP66 and IP67 ratings and this is because in some instances the IP66 requirement is more onerous than the IP67 requirement. This is one of the most onerous water ingress tests and we designed specifically for electrical equipment which would be subject to deluge conditions, e.g. Ships decks, fire deluge areas. The following table shows the criterion for IP requirement to EN/IEC 60529.

First Digit		Degree of Protection	Second Digit		Degree of Protection
0		No protection	0		No protection
1		Protection against ingress of large solid particles	1		Protection against ingress of vertically dripping water
2		Protection against ingress of medium sized solid particles	2		Protection against ingress of water dripping at an angle of 75° to 90°
3		Protection against ingress of medium solid particles greater in thickness than 2.5mm	3		Protected against drops of water falling at up to 60° from the vertical
4		Protection against ingress of small solid foreign bodies greater in thickness than 1mm	4		Protected against projections of water from all directions
5		Protection against ingress of dust in an amount sufficient to interfere with enclosed equipment.	5		Protection against ingress of water jets
6		Complete Protection against ingress of dust	6		Protection against ingress of water in heavy water
			7		Protection against effects of temporary immersion
			8		Protection against effects of indefinite immersion

IP TEST METHOD

- IP X6 : Spraying 100 liters of water per minute through 12.5mm nozzle from 3m away for 3minutes.
- IP X7 : Immersing in the depth of less than 1m for 30min.
- IP X8 : According to the conditions requested by the manufacturer.







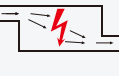

IEC INTRODUCTION

The IECEx is a single global certification framework to facilitate international trade in equipment and services for use in explosive atmosphere based on the IEC(International Electrotechnical Commission)'s international standard while maintaining the required level of safety:

- Reduced testing and certification costs to manufacturer
- Reduced time to market
- International confidence in the product assessment process
- One interantional database listing

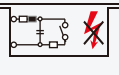
The goal is to help manufacturers reduce costs and time while developing and maintaining uniform product evaluation to protect users against products that are not in line with the required level of safety. So it should help industry to open up new markets from different conformity assessment criteria in various countries. The aim of the IECEx Scheme and its programs is to ease international trade of explosion protected equipment(termed Ex equipment) by eliminating the need for duplication of testing and certification while preserving safety. IECEx accepts the participation of Ex certification bodies and Ex test laboratories only after successful completion for the IEXEx Assessment Process which also includes on-going surveillance each Ex candidate certification body and testing laboratory is subjected to the same IECEx assessment process utilizing the internationally established ISO/IEC standards and guides on conformity assessment supplemented with the IECEx technical guidance documents with world experts in the field of explosion-potection being appointed as IECEx Assessors.

TYPE OF ENCLOSURE

Type of Enclosure	Basic Principle	Schematic	IEC Standard
Flame proof Enclosure d	A type of protection of electrical apparatus in which the enclosure will withstand an internal explosion of a flammable mixture which has penetrated into the interior, without suffering damage and without causing ignition, through any joints or structural openings in the enclosure, of an external explosive atmosphere consisting of one or more the gases or vapour for which it is designed.		IEC 60079-1
Pressurized Enclosure p	A type of protection in which the entry of a surrounding atmosphere into the enclosure of the electrical apparatus is prevented by maintaining inside the said enclosure a protective gas at a higher pressure than that of the surrounding atmosphere.		IEC 60079-2
Powder Filling q	A type of protection in which the enclosure of electrical apparatus is filled with a material in a finely granulated state so that, in the intended conditions of service, any arc occurring within the enclosure of an electrical apparatus will not ignite the surrounding atmosphere.		IEC 60079-5
Oil Immersion o	A type of protection in which the electrical apparatus or parts of the electrical apparatus are immersed in oil in such a way that an explosive atmosphere, which may be above the oil or outside the enclosure cannot be ignited.		IEC 60079-6
Increased Safety e	A type of protection applied to electrical apparatus that does not produce arcs or sparks in normal service, in which additional measures are applied so as to give increased security against the possibility of excessive temperatures and of the occurrence of arcs and sparks.		IEC 60079-7
Intrinsic Safety i	A type of protection in which the electrical apparatus contains intrinsically safe circuits, which are incapable of causing an explosion in the surrounding atmosphere.		IEC 60079-11
Non-Sparking Structure n	A type of protection where electrical equipment, in normal operation, is not capable of igniting a surrounding explosive gas atmosphere and a fault capable of causing ignition is not likely to occur.		IEC 60079-15
Encapsulation m	A type of protection in which the parts which can ignite an explosive atmosphere are enclosed in a resin sufficiently resistant to environmental influences in such a way that this explosive atmosphere cannot be ignited by either sparking or heating, which may occur within the encapsulation.		IEC 60079-18
Dust Ignition Protection DIP	An enclosure that will exclude ignitable amounts of dusts that might affect performance or rating and that, when installed and protected in accordance with the original design intent, will not permit arcs, sparks, or heats otherwise generated or liberated inside the enclosure to cause ignition of exterior accumulations or atmospheric suspensions of a specified dust.		

ATEX MARKING (EUROPEAN)

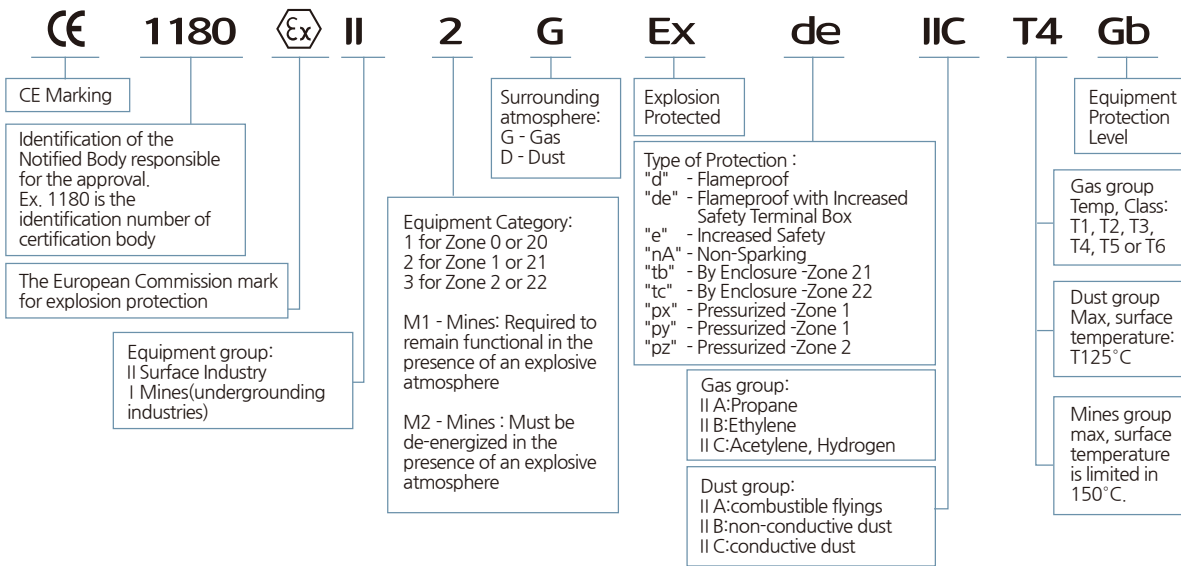

IECEX MARKING (GLOBAL)

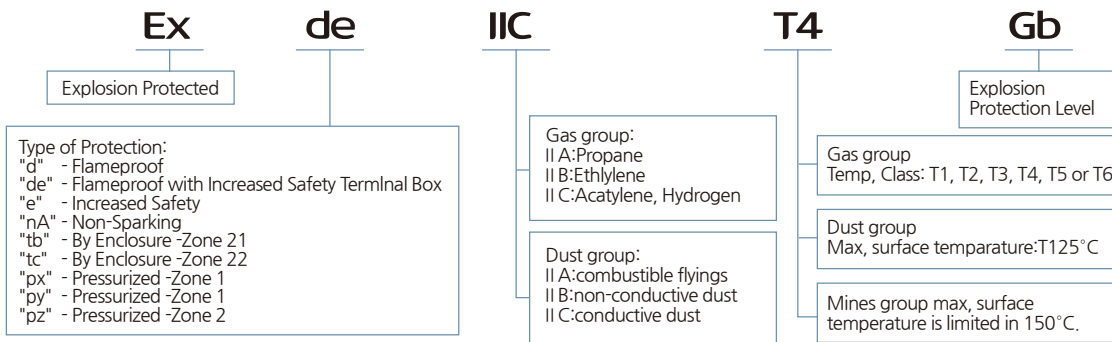

NORTH AMERICAN MARKING

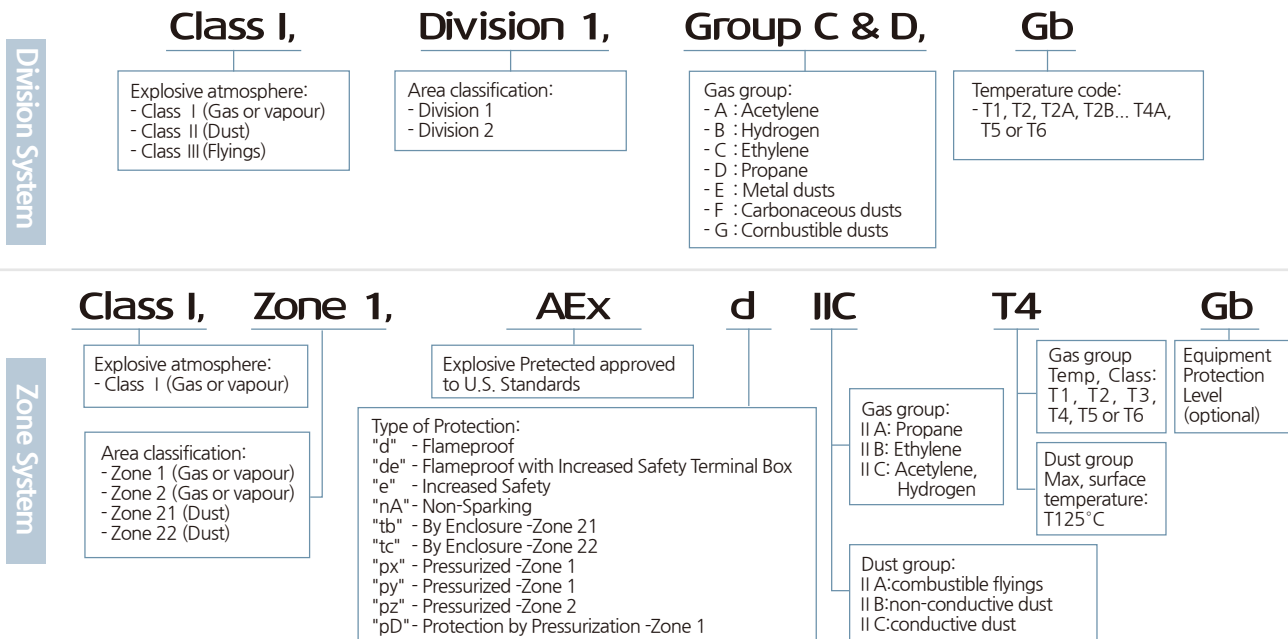

(1) For Dust environments (Zone 21 or 22) the Class of the hazard (Class II) shall not be mentioned in the marking. e.g. Zone 21, AEx tb IIC T125°C Db

(2) For Canadian Standards letter "A" shall not be mentioned in the marking. e.g. Class I, Zone I, Ex d IIC T4 Gb

(3) Certificates emitted according to the new standards versions require the EPL marking close to protection type. e.g. Ex db eb (Old: Ex de)

INSTALLATION MANUAL FOR OSCG CABLE GLAND TYPE OS-EXBF

Application(Barrier Gland for Any Type of Armoured Cable)

- IECEx PRE 18.0074X
- Presafe 18 ATEX 13521X
- KCS 18-KA2BO-0713~4X
- II2G Ex db IIC Gb
- II2G Ex eb IIC Gb
- II2D Ex tb IIIC Db
- O.T -60°C~110°C
- IP 66 / 68

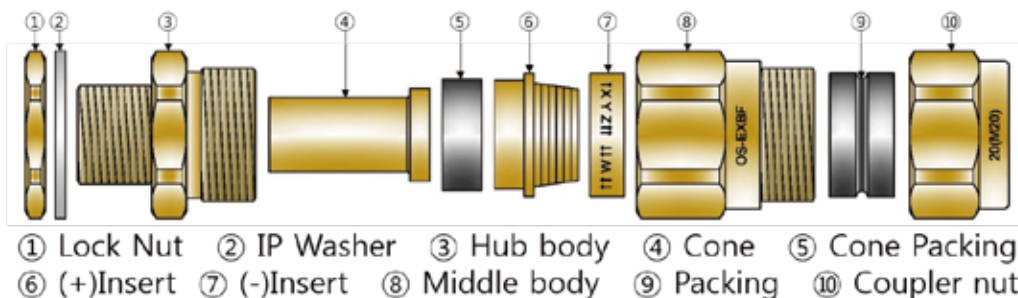

Preparation material

vernier calipers, spanner 2ea, ruler, pen, clipper, cutter, compound set, cable cutter, tape, compass saw, -driver

Installation Order

1. Separate gland components

2. Tighten Hub body(③) with an enclosure or equipment(※ Tighten lock nut(①) by spanner)



3. Put (-)Insert(⑦), Middle body(⑧), Coupler nut(⑩) through cable.(Disassemble Middle(⑧) body from Couler nut(⑩) to remove sheet)

※ BS 6121 Type of Gland(The suffix of each type of protection)

☞ Single wire : W, Wire braided : X, Aluminium strip : Y, Steel tap : Z



4. Remove unnecessary armour and Outer sheath.(Use compass saw)

※ A : Range of remove Outer sheath

Gland Size	Remove range
16 ~ 32	15 ~ 20mm
40 ~ 115	25 ~ 32mm

※ Be careful of armour not to be damaged



5. Remove Inner sheath except B(Use cable cutter or cutter)

※ B : Range of except Inner sheath

Gland Size	Range of except
16 ~ 32	15mm
40 ~ 115	25mm

※ Be careful of core not to be damaged

※ Need to tape the end of cores



6. Use -driver to separate the exposed wire from the inner sheath and then Put (+)Insert(⑥) through Inner sheath

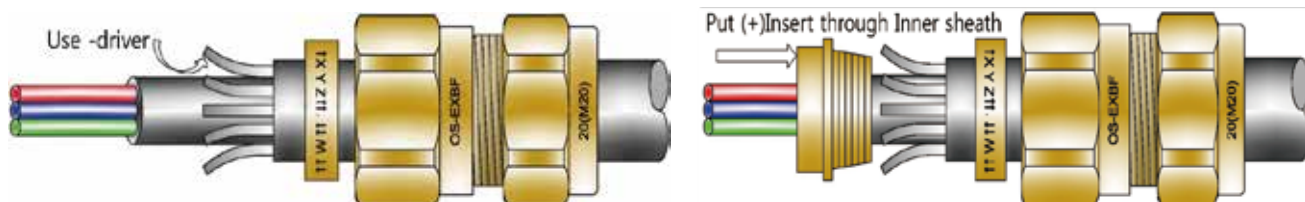

7. Place bottom part of (+)Insert(⑥) under armour and (-)Insert(⑦) is move to top side of armour



8. Put the cable and Cable gland through the Hub body(③)

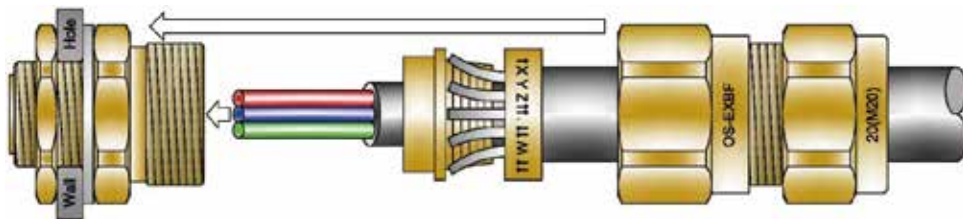

9. Armour clamping work(Hub body(③) ← (+)Insert(⑥) ← (-)Insert(⑦) ← Middle body(⑧) ← Coupler nut(⑩)

※ Tighten gland by spanners until some friction sounds twice

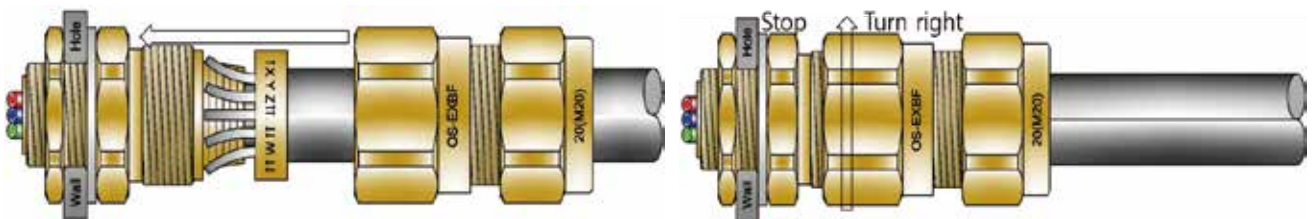

10. Untighten Middle body(⑧) to check clamping condition(Use spanner)

- ※ (+)/(-) Inserts are not mandatorily attached due to the thickness of armour as long as (+)/(-) Inserts are not loosen
- ※ Need to check (-)Insert direction



11. Fill compound inside cone

- ※ Make sure compound filled between cores
- ※ If the compound overflows on cone, wipe off compound immediately. Immediately wash if in contact with human body
- ※ Recommended compound (50ml) use per gland size table(Right side)
- ※ Before use compound, waste it by pressing the gun full 2 times for equivalent mixing between epoxy and hardener, then fill the cone.

Abient Temp.	10 °C	20 °C	30 °C	40 °C
Curing Time	10 Min	8 Min	6 Min	3 Min

※ Heat rises from 30°C ~ 60°C when curing

Gland Size	16	20	25	32	40	50/63/63X	75/75X	90/100	115
Recommended compound(50ml) use per gland size	1/10	1/8	1/6	1/2	1	2	2.5	3	3.5

12. Assemble all gland components and Check out the tightening condition of Coupler nut(⑩)

1. Tighten Middle body(⑨) to Hub body(③)
 2. Tighten Coupler nut(⑩) to Middle body(⑨)
- ※ To ensure IP grade, tighten using tools
 - ※ Tighten the Coupler Nut(⑩) by 1/2 to 1 turn with a spanner.
 - ※ Be careful of Check point with no gap

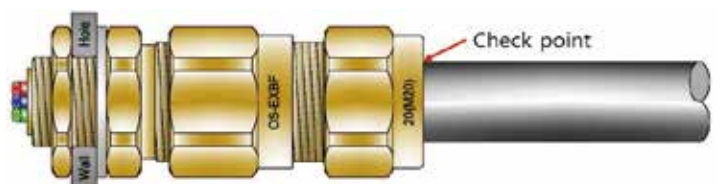

THE TYPE OF THREAD ON CABLE GLAND

- 01 JIS B0202 Standard PF(=G) thread
- 02 JIS B0203 Standard PT thread
- 03 ANSI/ASME-B 1201 Standard NPT thread
- 04 DIN 40430 Standard PG thread
- 05 ISO 965-1&3 Standard ISO Metric thread

| PF(=G) thread (Pipe straight thread)

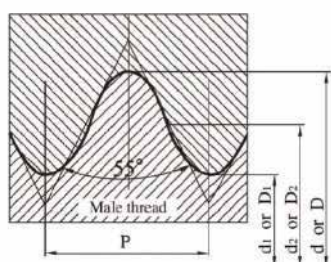

JIS B0202

Units : mm

Nominal size	Number of threads per inch	Pitch p (Ref.)	Depth of threads h	Crest/root radius r	Male thread		
					O.D d	Effective diameter d2	Diameter at root d1
					Female thread		
					Diameter at root D	Effective diameter d2	I.D D1
PF 1/2"	14	1.8143	1.162	0.25	20.955	19.793	18.631
PF 3/4"	14	1.8143	1.162	0.25	26.441	25.279	24.117
PF 1"	11	2.3091	1.479	0.32	33.249	31.770	30.291
PF 1-1/4"	11	2.3091	1.479	0.32	41.910	40.431	38.952
PF 1-1/2"	11	2.3091	1.479	0.32	47.803	46.324	44.845
PF 2"	11	2.3091	1.479	0.32	59.614	58.135	56.656
PF 2-1/2"	11	2.3091	1.479	0.32	75.184	73.705	72.226
PF 3"	11	2.3091	1.479	0.32	87.884	86.405	84.926
PF 3-1/2"	11	2.3091	1.479	0.32	100.330	98.851	97.372
PF 4"	11	2.3091	1.479	0.32	113.030	111.551	110.072

| PT thread (Pipe taper thread)

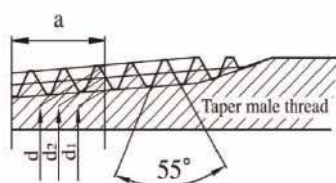

JIS B0203

Units : mm

Nominal size	Thread			Length a	Basic diameters		
	Number of threads per inch	Pitch p	Depth of threads h		O.D d	Effective diameter d2	Diameter at root d1
PT 1/2"	14	1.814	1.162	8.16	20.955	19.793	18.631
PT 3/4"	14	1.814	1.162	9.53	26.441	25.279	24.117
PT 1"	11	2.309	1.479	10.39	33.249	31.77	30.291
PT 1-1/4"	11	2.309	1.479	12.70	41.91	40.431	38.952
PT 1-1/2"	11	2.309	1.479	12.70	47.803	46.324	44.845
PT 2"	11	2.309	1.479	15.88	59.614	58.135	56.656
PT 2-1/2"	11	2.309	1.479	17.46	75.184	73.705	72.226
PT 3"	11	2.309	1.479	20.64	87.884	86.405	84.926
PT 3-1/2"	11	2.309	1.479	22.23	100.330	98.851	97.372
PT 4"	11	2.309	1.479	25.40	113.03	111.551	110.072

NPT thread (American taper thread)

Units : mm

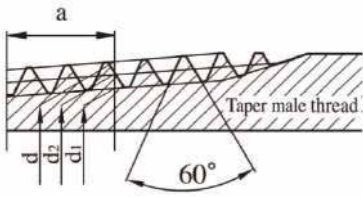

ANSI / ASME-B 1201

Nominal size	Thread			Basic diameters			
	Number of threads per inch	Pitch p	Depth of threads h	Length a	O.D d	Effective diameter d2	Diameter at root d1
NPT 1/2"	14	1.814	1.451	8.128	21.223	19.772	18.321
NPT 3/4"	14	1.814	1.451	8.61	25.117	23.666	20.764
NPT 1"	11.5	2.208	1.766	10.16	33.227	31.461	29.695
NPT 1-1/4"	11.5	2.208	1.766	10.668	41.983	40.217	38.451
NPT 1-1/2"	11.5	2.208	1.766	10.668	48.053	46.287	44.521
NPT 2"	11.5	2.208	1.766	11.074	60.091	58.325	56.55
NPT 2-1/2"	8	3.175	2.54	17.322	72.698	70.158	67.61
NPT 3"	8	3.175	2.54	19.456	88.607	86.067	83.52
NPT 3-1/2"	8	3.175	2.54	20.853	101.6	98.776	97.473
NPT 4"	8	3.175	2.54	21.437	113.972	111.432	108.892

PG thread (German pipe thread)

Units : mm

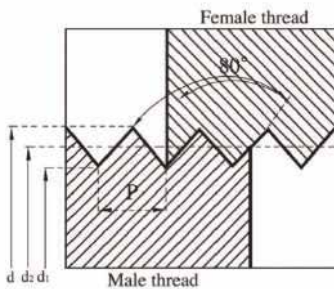

DIN 40430

Nominal size	Number of threads per inch	Pitch p (Ref.)	Height of contiguous surface H1	Male thread			Minimum diameter of mounting hole in box
				O.D d	Effective diameter d2	Diameter at root d1	
				Diameter at root D	Effective diameter d2	I.D D1	
PG 7	20	1.270	0.61	12.5	11.89	11.28	13
PG 9	18	1.411	0.67	15.2	14.53	13.86	16
PG 11	18	1.411	0.67	18.6	17.93	17.36	19
PG 13.5	18	1.411	0.67	20.4	19.73	19.06	21
PG 16	18	1.411	0.67	22.5	21.83	21.16	23
PG 21	16	1.588	0.76	28.3	27.54	26.78	29
PG 29	16	1.588	0.76	37	36.24	35.48	38
PG 36	16	1.588	0.76	47	46.24	45.48	48
PG 42	16	1.588	0.7	54	53.24	52.48	55
PG 48	16	1.588	0.76	59.3	58.54	57.78	60

ISO Metric thread

Units : mm

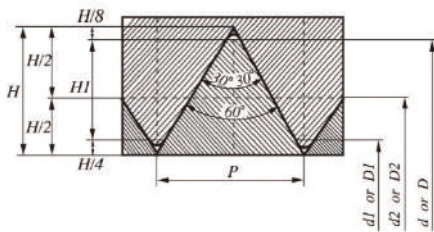

$$H = 0.866025 P \quad d_2 = d - 0.649519 P$$

$$H = 0.541266 P \quad d_1 = d - 1.082532 P$$

$$D = d \quad D_2 = d_2 \quad D_1 = d_1$$

KS B 0204-86 JIS B 0207-1982

Nominal size	Pith P	Diameter D	Effetiv Diameter d2	Diameter at root d1
M16	1.5	16	15.026	14.376
M20	1.5	20	19.026	18.376
M24	1.5	24	23.026	22.376
M25	1.5	25	24.026	23.376
M27	1.5	27	26.026	25.376
M30	1.5	30	29.026	28.376
M32	1.5	32	31.026	30.376
M36	1.5	36	35.026	34.376
M40	1.5	40	39.026	38.376
M42	1.5	42	41.026	40.376
M45	1.5	45	44.026	43.376
M50	1.5	50	49.026	48.376
M55	1.5	55	54.026	53.376
M56	1.5	56	55.026	54.376
M60	1.5	60	59.026	58.376
M63	1.5	63	62.026	61.376
M65	1.5	65	64.026	63.376
M70	1.5	70	69.026	68.376
	2.0	70	68.701	67.835
M72	1.5	72	71.026	70.376
	2.0	72	70.701	69.835
M75	1.5	75	72.026	73.376
	2.0	75	73.701	72.835
M90	2.0	90	88.701	87.835
M100	2.0	100	98.701	97.835

OSCG Since November 1983.



Overseas Agencies

	AUSTRALIA	HASTINGS ELECTRICAL PTY LTD. / TEL : +61 02 9625 7744 / FAX : +61 2 9625 7755
	CANADA	ASHCON INTERNATIONAL INC. / TEL : +1 905 569 2300 / FAX : +1 905 569 2301
	CHINA	CANOEWELL / TEL : +86 411 3955 9361
	EGYPT	PULLMAN ELECTRIC / TEL: +2 02 25 285 832
	GERMANY	WISKA Hoppman GmbH / TEL : +49 4191 508 0 / FAX : +49 4191 508 249
	IRAN	TOSSAE PAYAM ZAGROS LTD. / TEL : +98 021 77174074 / +98 09121091565
	INDONESIA	PT JAMELCA INDO KAJA / TEL : +62 21 5366 0984
	ITALY	MACHINERY AND REPLACEMENT PARTS / TEL : +39 10 8937265 / FAX : +39 10 8937267
	KUWAIT	NOURAS AL BAHAR CO, W,L,L / TEL : +965 24829310 / FAX : +965 24829312
	MALAYSIA	ARMADA DIMENSI / TEL : +603 3362 6283 / FAX : +603 5122 2619
	NIGERIA	PLATINUM SAMANDY VENTURES(PSV) / TEL : +234 8574072031 / FAX : +234 14630015
	NORWAY	AUTEK / TEL : +47 322 19200 / FAX : +47 322 19201
	OMAN	AL-IBRAM LLC / TEL : +968 241 846 91 / FAX : +968 241 846 92
	PAKISTAN	SAGE OILFIELD SERVICES / TEL : +92 21 34386844 / FAX : +92 21 34386791
	QATAR	TRANS ARABIA TRADING & CONTRACTING CO.,LTD. / TEL : +974 4450 1517 / FAX : +974 4450 1527
	ROMANIA	EMCO STAR S,R,L / TEL : +40 241 519410
	RUSSIA	EUROPRIBOR CO.,LTD. / TEL : +7 495 989 22 76
	SAUDI ARABIA	SAMA AL SHAQRAN TRADING EST / TEL : +966592264316
	SINGAPORE	LIKO TRADE CENTRE PTE LTD. / TEL : +65 6284 1819 / FAX : +65 6284 5727
	SPAIN	INPRATEX / TEL : +34 943 530 095 / FAX : +34 943 530 482
	THAILAND	4484 HOLDING / TEL : +66 2488 8884 / FAX : +66 2033 7559
	UAE	PETROLCOM OIL & GAS SERVICES / TEL : +971-2-4089444
	VIETNAM	HOA PHAT TECHNOLOGY CO.,LTD. / TEL : +84 8 62970026 / FAX : +84 8 38916332
	INDIA	UNITED LIGHTING TECHNOLOGY / TEL : +91 99232 96600



Seoul Branch
OSCG SEOUL
Seoul Agency
PROCESS CONTROLS CO.,LTD.

Ulsan Branch
OSCG ULSAN

Busan Branch
OSCG B,S,S
OSCG G,Y,S
DYNASTY SOLUTION CO.,LTD.

Busan Agency
E,E,C WORLD
MJ TECH CO.,LTD.
SECHANG CORP.

Business Office

DYNASTY 다이너스티

TEL : +82 51 305-3445 / FAX : +82 51 305 3447

OSCG BUSAN GANGSEO(BUSAN KOREA) 부산강서지사

TEL : +82 51 796 3910 / FAX : +82 51 796 3915

OSCG BUSAN SASANG(BUSAN KOREA) 부산사상지사

TEL : +82 51 319 3925 / FAX : +82 51 319 3926

OSCG SEOUL (SEOUL KOREA) 서울지사

TEL : +82 2 2633 2460 / FAX : +82 2 2633 2463

OSCG ULSAN (ULSAN KOREA) 울산지사

TEL : +82 52 260 3910 / FAX : +82 52 260 3926

Overseas Business Office

OSCG JAPAN(TOKYO JAPAN) 일본 도쿄지사

TEL : +81 3 3263 2031 / FAX : +81 3 3263 2034

Local Agencies

E,E,C WORLD 세계전통

TEL : +82 51 714 5000 / FAX : +82 51 714 5001

KOREA ELECTRICS CO., LTD. 한국전기상사

TEL : +82 52 266 0900 / FAX : +82 55 266 0902

MJ TECH CO.,LTD. (주)엠제이테크

TEL : +82 51 245 0511 / FAX : +82 51 241 2367

PROCESS CONTROLS CO.,LTD. 프로세스콘트롤즈(주)

TEL : +82 2 6344 2800 / FAX : +82 2 6344 2810

SECHANG CORP. 세창상사

TEL : +82 51 804 6786~7 / FAX : +82 51 804 6789





HEAD OFFICE

OSCG HQ

Add. 1242, Nakdongdaero Sasang-Gu, Busan, Korea Postal code 46912
Tel. +82 51 305 3909 / 3910
Fax. +82 51 305 3933
Email. oscg@oscg.net

OSEG & OSCG RESEARCH INSTITUTE

22, Mora-ro, Sasang-Gu, Busan, Korea

SUBSIDIARY

DYNASTY(BUSAN)

Add. 1360 Nakdong-Daero, Sasang gu, Busan, Korea
Tel. +82 51 305 3445 Fax. +82 51 305 3447

BUSINESS OFFICE

OSCG SEOUL

Add. 30-105, D Block, Seoul Industrial Tools
Commercial Cooperative 198, Gurojungang-ro,
Guro-gu, Seoul, Korea

Tel. +82 2 2633 2460 Fax. +82 2 2633 2463

OSCG BUSAN GANGSEO

Add. 116-114 / 214, Busan T-FLEX37, Yutongdanji 1-ro,
Gangseo-gu, Busan, Korea

Tel. +82 51 796 3910 Fax. +82 51 796 3915

OSCG BUSAN SASANG

Add. 9-132, Industrial Good Distribution Center, 37,
Gwaigamro, Sasang-gu, Busan, Korea

Tel. +82 51 319 3925 Fax. +82 51 319 3926

OSCG ULSAN

Add. 255, Deokha-ro, Cheongnyang-myeon, Ulsan, Korea

Tel. +82 52 260 3910 Fax. +82 52 260 3926

OVERSEAS BUSINESS OFFICE

OSCG JAPAN TOKYO

Add. 3-4-3 401 IIDABASHI CHIYODA KU TOKYO, JAPAN, 102-0072

Tel. +82 3 3263 2031 Fax. +82 3 3263 2034



[Catalog Download](#)